

LCD Digital Colour TV

Operating Instructions

Getting Started

Using Your BRAVIA TV

Network Setup

Additional Information

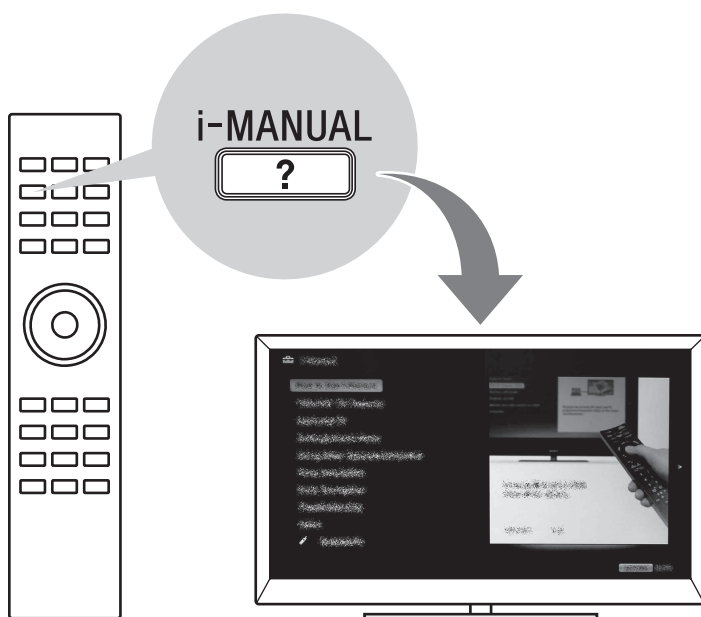

BRAVIA

Introduction

Thank you for choosing this Sony product. Before operating the TV, please read this manual thoroughly and retain it for future reference.



- The “x” that appears in the model name corresponds to a numeric digit, related to design, colour or TV system.
- Instructions about “Installing Wall Mount Bracket” are included within this TV’s instructions manual.
- The illustrations used in this manual are of the KDL-46NX720 series unless otherwise stated.
- The illustrations of the remote control used in this manual are of the RM-GD017 unless otherwise stated.
- Before operating the TV, please read “Safety Information” (page 32). Retain this manual for future reference.

Trademark information

DVB is a registered trademark of the DVB Project.

HDMI, the HDMI Logo, and High-Definition Multimedia Interface are trademarks or registered trademarks of HDMI Licensing LLC in the United States and other countries.

DLNA® and DLNA CERTIFIED® are trademarks and/or service marks of Digital Living Network Alliance.

DivX® is a video file compression technology, developed by DivX, Inc.

DivX®, DivX Certified®, and associated logos are trademarks of DivX, Inc. and are used under license.

ABOUT DIVX VIDEO: DivX® is a digital video format created by DivX, Inc. This is an official DivX Certified device that plays DivX video. Visit www.divx.com for more information and software tools to convert your files into DivX video.

ABOUT DIVX VIDEO-ON-DEMAND: This DivX Certified® device must be registered in order to play DivX Video-on-Demand (VOD) content. To generate the registration code, locate the DivX VOD section in the device setup menu. Go to vod.divx.com with this code to complete the registration process and learn more about DivX VOD.

Manufactured under license from Dolby Laboratories. Dolby and the double-D symbol are trademarks of Dolby Laboratories.

“BRAVIA” and BRAVIA are trademarks of Sony Corporation.

“FACE DETECTION” logo is trademark of Sony Corporation.

TrackID is a trademark or registered trademark of Sony Ericsson Mobile Communications AB.

Music and video recognition technology and related data are provided by Gracenote®. Gracenote is the industry standard in music recognition technology and related content delivery. For more information, please visit www.gracenote.com.

CD, DVD, Blu-ray Disc, and music and video-related data from Gracenote, Inc., copyright © 2000-present Gracenote. Gracenote Software, copyright © 2000-present Gracenote. One or more patents owned by Gracenote apply to this product and service. See the Gracenote website for a nonexhaustive list of applicable Gracenote patents. Gracenote, CDDB, MusicID, MediaVOCS, the Gracenote logo and logotype, and the “Powered by Gracenote” logo are either registered trademarks or trademarks of Gracenote in the United States and/or other countries.

Opera® Browser from Opera Software ASA. Copyright 1995-2010 Opera Software ASA. All rights reserved.



Notes for Australia and New Zealand model

This product is ENERGY RATING qualified in the “Home” mode. ENERGY RATING is a program designed to promote energy efficient products and practices.

- When the TV is initially set up, it is designed to meet ENERGY RATING requirements while maintaining optimum picture quality.
- Changes to certain features, settings, and functionalities of this TV (e.g. TV Guide, Picture/Sound, Eco-Setting) can slightly change the power consumption.

Depending upon such changed settings (e.g. “Shop” mode), the power consumption may vary which possibly could exceed the stated energy rating.

To reset the TV to ENERGY RATING qualified settings, select “Home” mode from the initial set-up procedure in “Factory Settings” under the “Set-up” menu.

IMPORTANT INFORMATION

If a television is not positioned in a sufficiently stable location, it can be potentially hazardous due to falling. Many injuries, particularly to children, can be avoided by taking simple precautions such as:

- Using cabinets or stands recommended by the manufacturer of the television.
- Only using furniture that can safely support the television.
- Ensuring the television is not overhanging the edge of the supporting furniture.
- Not placing the television on tall furniture (for example, cupboards or bookcases) without anchoring both the furniture and the television to a suitable support.
- Not standing the televisions on cloth or other materials placed between the television and supporting furniture.
- Educating children about the dangers of climbing on furniture to reach the television or its controls.

Notice for customers in the South Africa

The Euro/South Africa converter plug should be fitted as follows.

- 1 Insert the power supply or CEE7 plug in to the converter plug.
- 2 Use an appropriate screwdriver to attach the screw tightly without damaging the screw head.
- 3 TEST: Grip the converter plug, and pull the VDE cord set/transformer to ensure it is fully secure, if not then increase the torque setting and further tighten. Re-test.

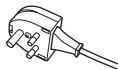
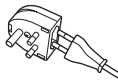
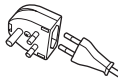

The converter plug is now ready for use.

Notice for customers in Thailand

This telecommunication equipment conforms to NTC technical requirement.

Notice for customers in Singapore

Complies with IDA Standards DB00353

Notice for customers in India

Attach the supplied plug adaptor.

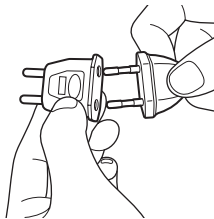

Notice for customers in Jordan

All models covered by this Instruction Manual contains wireless module DWM-W046 with approval number TRC/SS/2010/135.

Location of the identification label

Labels for Model No. and Power Supply rating (in accordance with applicable safety regulation) are located on the rear of the TV.

Precautions

Viewing the TV

- Some people may experience discomfort (such as eye strain, fatigue, or nausea) while watching 3D video images or playing 3D video games. Sony recommends that all viewers take regular breaks while watching 3D video images or playing 3D video games. The length and frequency of necessary breaks will vary from person to person. You must decide what works best. If you experience any discomfort, you should stop watching the 3D video images or playing 3D video games until the discomfort ends; consult a doctor if you believe necessary. You should also review (i) the instruction manual of any other device or media used with this television and (ii) our website (<http://www.sony-asia.com/support>) for the latest information. The vision of young children (especially those under six years old) is still under development. Consult your doctor (such as a pediatrician or eye doctor) before allowing young children to watch 3D video images or play 3D video games. Adults should supervise young children to ensure they follow the recommendations listed above.
- When using the simulated 3D function, please note that the displayed image is modified from the original due to the conversion done by this television.
- View the TV in moderate light, as viewing the TV in poor light or during long period of time, strains your eyes.
- When using headphones, adjust the volume so as to avoid excessive levels, as hearing damage may result.

LCD Screen

- Although the LCD screen is made with high-precision technology and 99.99% or more of the pixels are effective, black dots may appear or bright points of light (red, blue, or green) may appear constantly on the LCD screen. This is a structural property of the LCD screen and is not a malfunction.
- Do not push or scratch the front filter, or place objects on top of this TV set. The image may be uneven or the LCD screen may be damaged.
- If this TV set is used in a cold place, a smear may occur in the picture or the picture may become dark. This does not indicate a failure. These phenomena disappear as the temperature rises.
- Ghosting may occur when still pictures are displayed continuously. It may disappear after a few moments.
- The screen and cabinet get warm when this TV set is in use. This is not a malfunction.
- The LCD screen contains a small amount of liquid crystal. Some fluorescent tubes used in this TV set also contain mercury (except LED backlight LCD TV). Follow your local ordinances and regulations for disposal.
- Do not subject the LCD screen to any strong impact or shock. The screen glass may crack or shatter and cause injury.



Handling and cleaning the screen surface/cabinet of the TV set

Be sure to unplug the AC power cord connected to the TV set from AC power outlet before cleaning.

To avoid material degradation or screen coating degradation, observe the following precautions.

- To remove dust from the screen surface/cabinet, wipe gently with a soft cloth. If dust is persistent, wipe with a soft cloth slightly moistened with a diluted mild detergent solution.
- Never spray water or detergent directly on the TV set. It may drip to the bottom of the screen or exterior parts and enter the TV set, and may cause damage to the TV set.



- Never use any type of abrasive pad, alkaline/acid cleaner, scouring powder, or volatile solvent, such as alcohol, benzene, thinner or insecticide. Using such materials or maintaining prolonged contact with rubber or vinyl materials may result in damage to the screen surface and cabinet material.
- Periodic vacuuming of the ventilation openings is recommended to ensure to proper ventilation.
- When adjusting the angle of the TV set, move it slowly so as to prevent the TV set from moving or slipping off from its table stand.

Optional Equipment

Keep optional components or any equipment emitting electromagnetic radiation away from the TV set. Otherwise picture distortion and/or noisy sound may occur.

Wireless Function of the unit

- Do not operate this unit near medical equipment (pacemaker, etc.), as malfunction of the medical equipment may result.
- Although this unit transmits/receives scrambled signals, be careful of unauthorised interception. We cannot be responsible for any trouble as a result.

(Caution about handling the remote control)

Notes

- Observe the correct polarity when inserting batteries.
- Do not use different types of batteries together or mix old and new batteries.
- Dispose of batteries in an environmentally friendly way. Certain regions may regulate the disposal of batteries. Please consult your local authority.
- Handle the remote with care. Do not drop or step on it, or spill liquid of any kind onto it.
- Do not place the remote in a location near a heat source, a place subject to direct sunlight, or a damp room.

**Disposal of the TV set
(Australian model only)**



**Disposal of Old
Electrical &
Electronic
Equipment
(Applicable in the
European Union
and other**

**European countries with
separate collection systems)**

This symbol is on the remote control.

Table of Contents

Getting Started

Checking the accessories	8
Inserting batteries into the remote.....	8
1: Attaching the Table-Top Stand (except KDL-65HX92x)	8
2: Adjusting the viewing angle of the TV	10
3: Connecting an antenna/cable/VCR.....	10
4: Connecting audio/video devices	11
5: Preventing the TV from toppling over.....	12
6: Bundling the cables.....	13
7: Performing the initial set-up	13

Using Your BRAVIA TV

Watching the TV.....	14
Selecting various functions and settings (Home Menu)	16
Displaying Operating Instructions (i-Manual)	18

Network Setup

Preparing a wired network	20
Preparing a wireless LAN.....	20
Setting up the Internet connection	21
If you cannot connect to the Internet.....	22
Adjusting the server display settings.....	22

Additional Information

Troubleshooting	24
Specifications	25
Installing the Accessories (Wall-Mount/Wall-Hanging Bracket)	27
Safety Information	32

After setting up your BRAVIA TV and learning basic operations with this manual, see the built-in manual (i-Manual) for further explanation of the features of your TV.

This TV has a built-in manual (i-Manual).

To access the i-Manual, press **i-MANUAL** on the remote, and select an item. For details, see page 18 of this manual. Contents of the i-Manual may differ depending on the model/region/area.

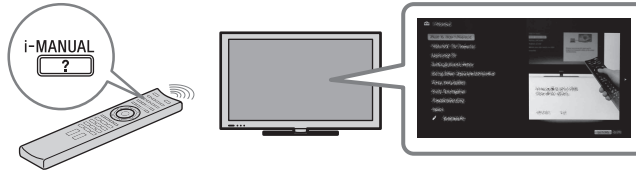

Contents of the i-Manual

* Some models do not have this feature.

How to Use i-Manual

“BRAVIA” TV Features

- 3D Feature
- Intelligent Presence Sensor
- “BRAVIA” Internet Video
- Internet Widgets
- Wireless LAN
- “BRAVIA” Sync with “Control for HDMI”
- Skype Ready*
- TrackID™/Music Search/Video Search

Watching TV

- 3D Feature
- Digital Electronic Programme Guide*
- Programme Guide for Digital Text*
- Favourites
- Wide Mode
- Picture Mode
- Text
- Photos/Music/Videos
- Twin Picture (PIP)
- Twin Picture (P&P)

Settings/Home Menu

- About the Home Menu
- Settings
- Display
- Sound
- System Settings

- i-Manual

- Digital Set-up*

- Analogue Set-up*

- External Inputs

- Network

- Product Support

Using Other Equipment/Internet

- VCR/DVD Player

- Audio System

- USB Device (e.g. Digital Camera)

- Picture Frame

- HDMI Equipment

- Internet/Wireless LAN

- Home Network

- Media Remote

- PC

- Programming the Remote*

Parts Description

- Remote

- TV Controls and Indicators

- Terminals

Troubleshooting

Index

✎ Bookmarks

Getting Started

Checking the accessories

Remote (1)

Size AAA batteries (R03 type) (2)

Table-Top Stand (1)*¹

(except KDL-65HX92x)

Fixing screws for Table-Top Stand

(M5 × 16) (3) (except KDL-65HX92x,

KDL-60NX72x)

Assembling screws for Table-Top Stand

(M6 × 14) (4) (for KDL-60/55/46NX72x,

KDL-55/46HX92x, KDL-55/46HX820)

Assembling screws for Table-Top Stand

(M6 × 14) (3) (for KDL-40NX72x)

Hexagon wrench (1)

Video/Component adapter (1)

(except KDL-65HX92x)

3D Glasses (battery included) (2)

(for KDL-65/55/46HX92x)

Pouch for 3D Glasses (2)

(for KDL-65/55/46HX92x)

Camera and Microphone Unit

(for KDL-65/55/46HX925)

Operating Instructions (this manual) and other documents

*¹ Assemble the Table-Top Stand with the supplied assembling screws. Refer to the supplied Table-Top Stand leaflet to assemble the stand.

Inserting batteries into the remote

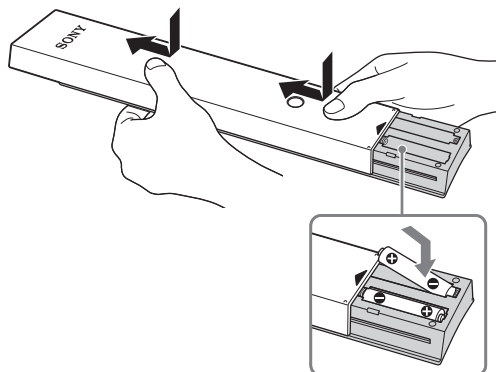

- 1 Remove the protection sheet.
- 2 Push and slide the cover upward.

1: Attaching the Table-Top Stand (except KDL-65HX92x)

Except KDL-60NX72x

- 1 Refer to the supplied Table-Top Stand leaflet for proper attachment for some TV models.
- 2 Place the TV set on the Table-Top Stand.

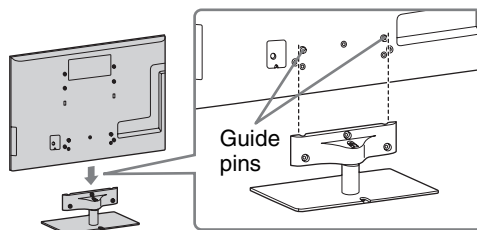

- Align the TV from the top, slide it in until the guide pins cannot be seen.

- 3** Fix the TV to the Table-Top Stand according to the arrow marks  that guide the screw holes using the supplied screws.

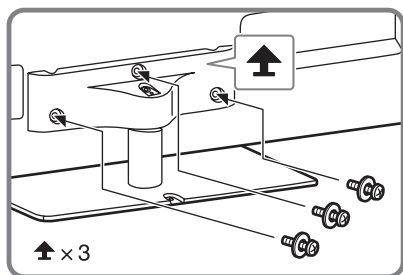

- If using an electric screwdriver, set the torque at approximately 1.5 N·m {15 kgf·cm}.

For KDL-60NX72x

- 1** Align with the two dowels of the Table-Top Stand, and gently place the TV, checking the  mark is facing the front.

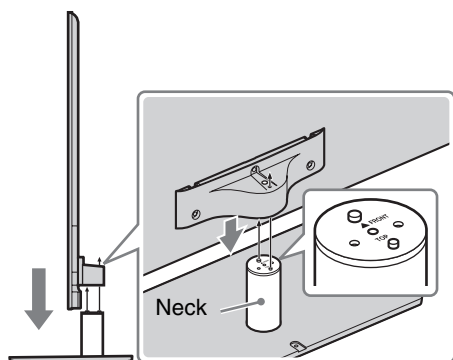

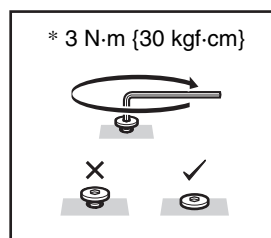
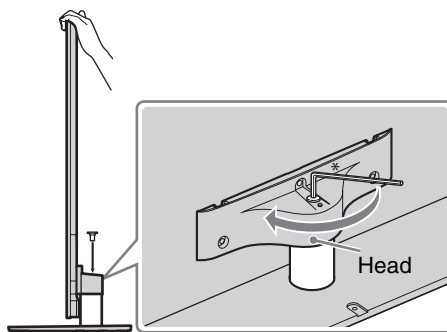

- 2** Attach the TV and Table-Top Stand with the supplied screw and hexagon wrench.



- Set the torque setting to approximately 3 N·m {30 kgf·cm}.

Detaching the Table-Top Stand from the TV

To detach the Table-Top Stand from the TV, remove the screws  fixed in step 3. For KDL-60NX72x, be sure to remove the screws  for detaching the head when the Table-Top Stand is not attached to the TV.

For KDL-65HX92x, be sure to remove the screws  at the head of the Table-Top Stand.

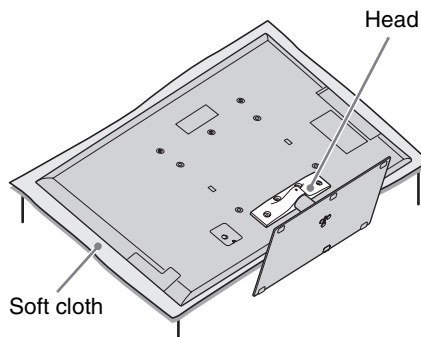



- Do not remove the Table-Top Stand for any reason other than to install corresponding accessories on the TV.
- When removing the Table-Top Stand from the TV, lay the display face down on a stable work surface that is larger than the TV.
- To prevent damaging the surface of the LCD display, make sure to place a soft cloth on the work surface.

2: Adjusting the viewing angle of the TV

This TV can be adjusted within the angles as illustrated.

Angle adjustment (Swivel) (except KDL-65HX92x, KDL-60NX72x)



- When adjusting the angle, hold the stand with one hand to avoid having the stand slip or TV tip over.

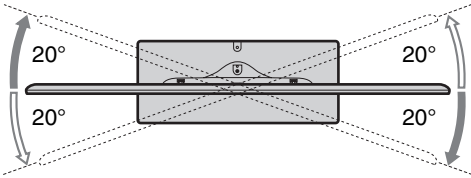

Angle adjustment (Tilt) (except KDL-65HX92x, KDL-60NX72x)

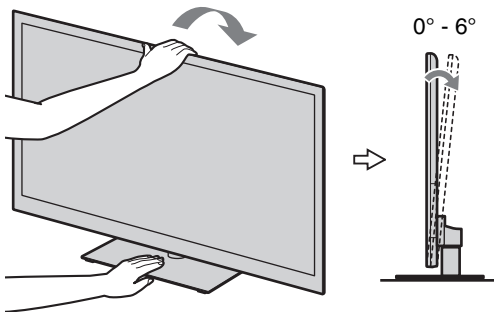

- Ensure that there are no objects in front of the TV.

IR Sensor

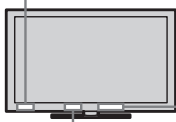

3D Sync Transmitter

Intelligent Presence Sensor

- Do not expose the Intelligent Presence Sensor to direct sunlight or other strong light, as malfunction may occur.

3: Connecting an antenna/cable/VCR



- Use an antenna cable connector no greater than 14 mm in thickness.
- Use an HDMI cable connector within 12 mm (thickness) x 21 mm (width).

Connecting an antenna/cable

► For KDL-65HX92x

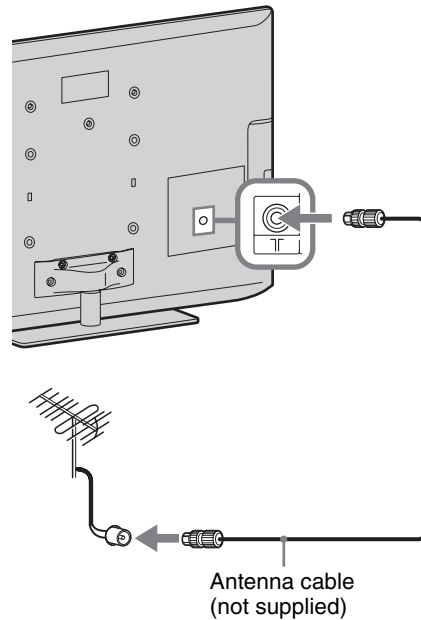

► Except KDL-65HX92x

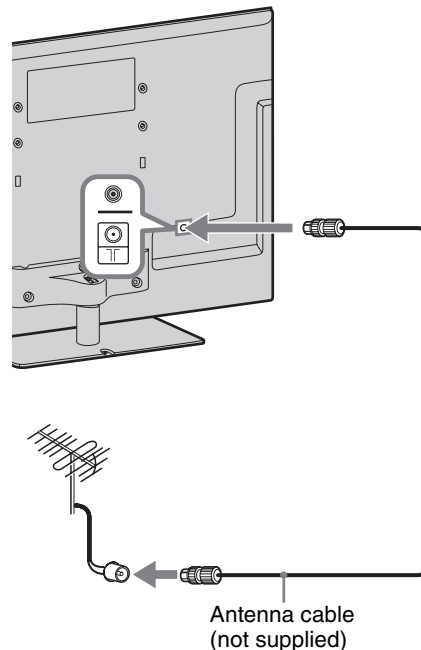

Connecting a Set Top Box/recorder (e.g. DVD recorder) with HDMI

► For KDL-65HX92x

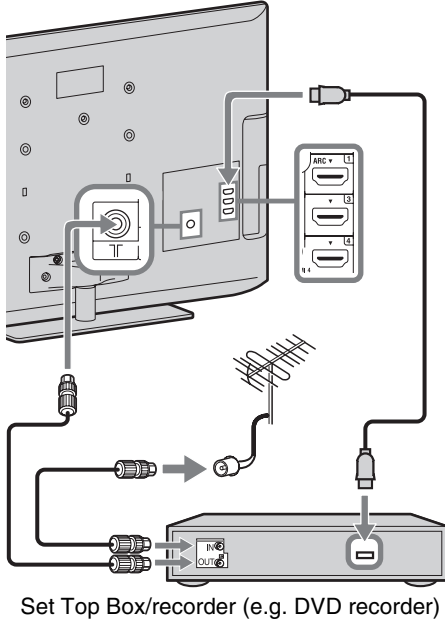

► Except KDL-65HX92x

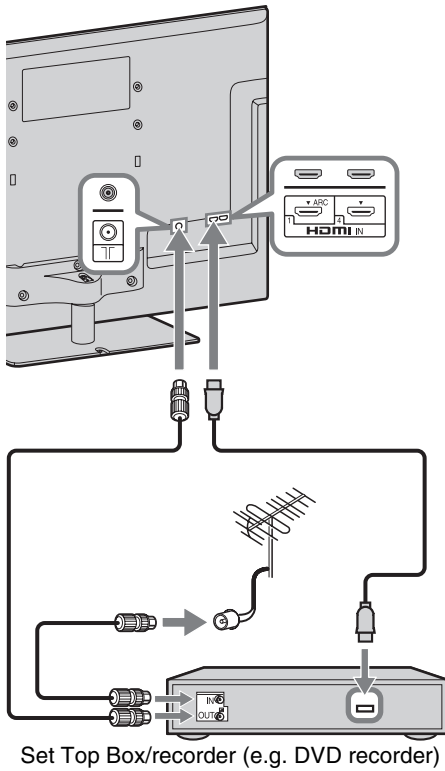

4: Connecting audio/video devices

► For KDL-65HX92x

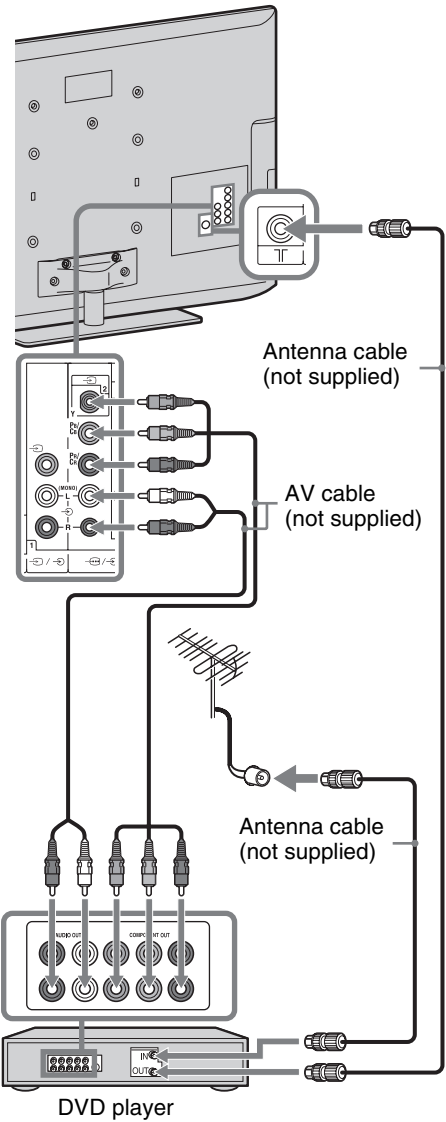

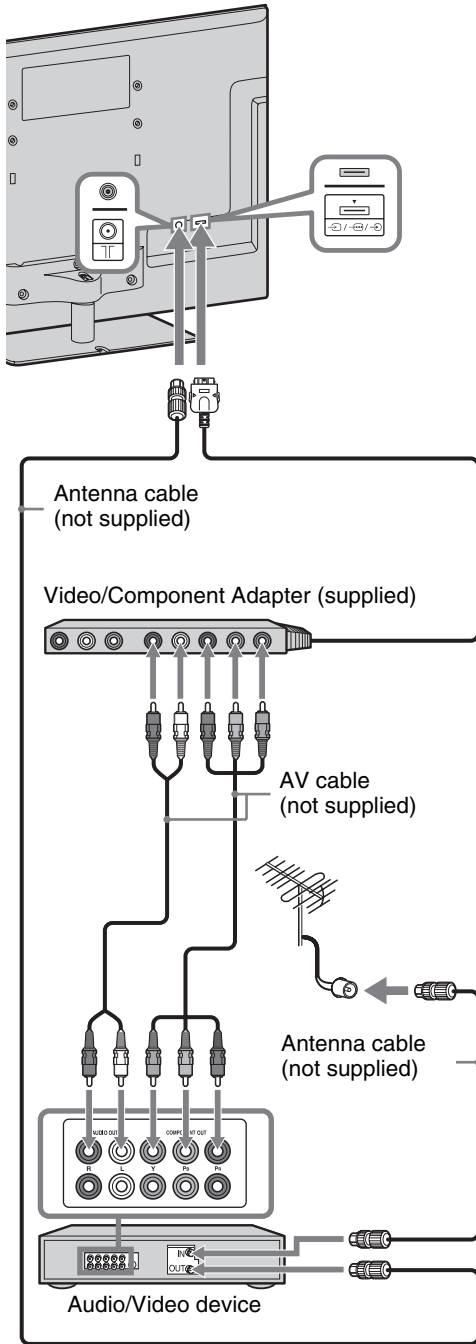

5: Preventing the TV from toppling over

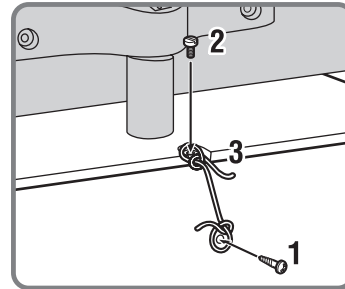
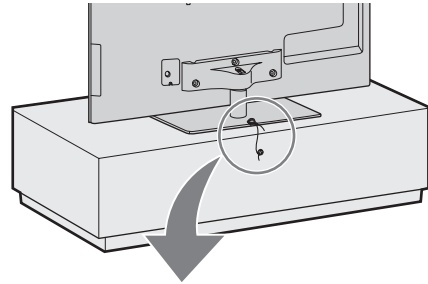

- 1** Install a wood screw (4 mm in diameter, not supplied) in the TV stand.
- 2** Install a machine screw (not supplied) into the screw hole of the TV.
For KDL-65HX92x
Use M6 screw
For KDL-60/55/46/40NX72x,
KDL-55/46HX92x, KDL-55/46HX820
Use M4 screw
- 3** Tie the wood screw and the machine screw with a strong cord (not supplied).

The length of the M6/M4 machine screw differs depending on the cord diameter. Please refer to below illustration.

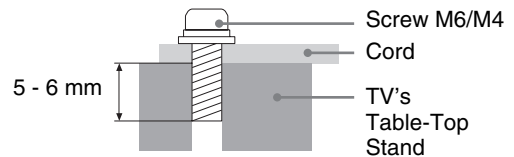

6: Bundling the cables



- Before bundling the cables, remove the cable holder from the AC cover (see step 1 and 2). Reuse the cable holder (see step 3) to bundle the other cables (see step 4).
- Do not bundle the AC power cord together with other cables.

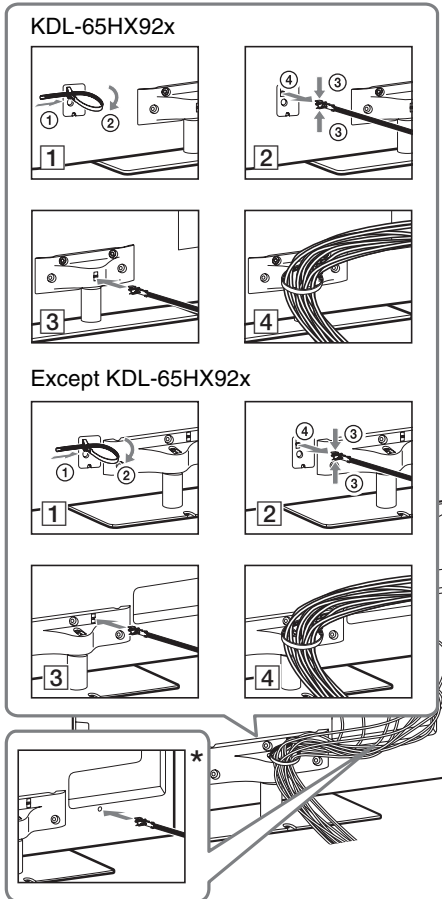

- * When installing on the wall, attach the cable holder under the terminals.

7: Performing the initial set-up

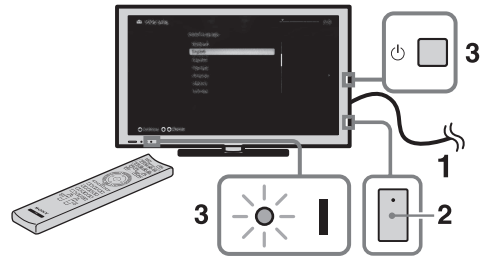

- 1 Connect the TV to your AC power outlet (mains socket).
- 2 Check the **ENERGY SAVING** switch setting is on (●).
- 3 Press on the TV. The **I** (power) indicator will light green.
When you switch on the TV for the first time, the Language menu appears on the screen.



- When you turn on the TV for the first time, the TV requires some internal processing for optimization before you can perform the initial setup. There will be no picture and sound, and the timer indicator on the front of the TV blinks orange for about 40 seconds. Do not turn off the TV during this process. This process has been completed at the factory on some TVs.

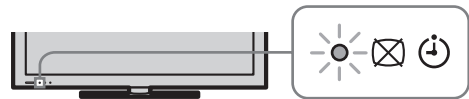

4

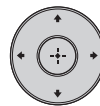

Follow the instructions on the screen.

Programme Sorting: Changes the order of analogue channels stored in the TV.

- 1 Press / to select the channel you want to move to a new position, then press .
- 2 Press / to select the new position for the channel, then press .



- You can also tune channels manually.

Using Your BRAVIA TV

Watching the TV

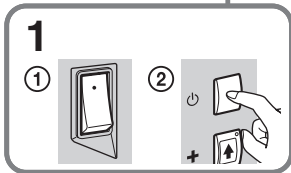
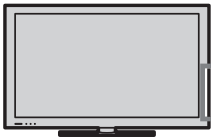

1 Turn on the TV.

- 1 Check the **ENERGY SAVING** switch setting is on (●).
- 2 Press on the TV to turn on the TV.

2 Select a mode.

DIGITAL/
ANALOG



3 Select a TV channel.

PROG



CH

To use Digital Electronic Programme Guide

Press **GUIDE** in digital mode to display the programme guide.



Use with **0-9** to select digital channels. For channel numbers 10 and above, press the next digit quickly.

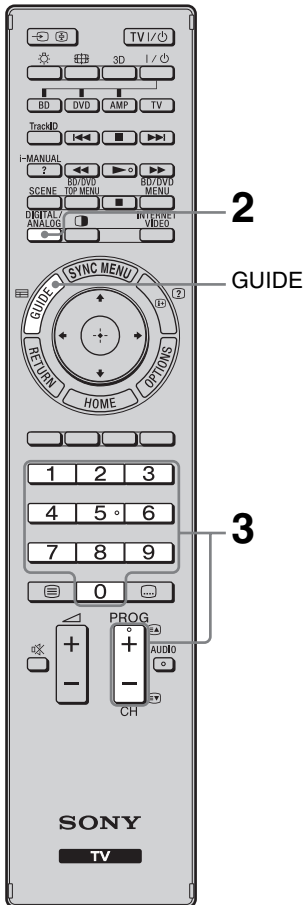

- The number **5**, , **PROG +** and **AUDIO** buttons on the remote have a tactile dot. Use the tactile dots as a reference when operating the TV.

Parts and controls of the remote

Use the supplied remote to control your TV. Basic remote operations are explained here. For details on all of the remote function, press **i-MANUAL** and see the built-in manual (i-Manual) (page 18).

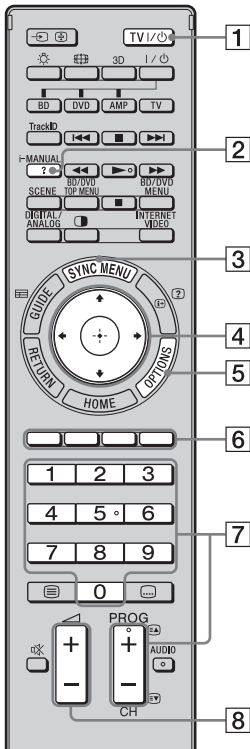

1 TV I/O

Press to turn the TV on and off from standby mode.

2 i-MANUAL

Displays the built-in manual (i-Manual).

3 SYNC MENU

Displays the BRAVIA Sync menu to operate the BRAVIA Sync-compatible equipment that is connected to the TV.

4

Moves the on-screen cursor, and confirm the item.

5 OPTIONS

Displays a list of convenient functions and menu shortcuts. The menu items vary based on the current input and/or content.

6 Coloured buttons

When the coloured buttons are available, an operation guide appears on the screen.

7 PROG/CH +/-/Number buttons

Select channels in the TV mode.

8

Adjusts the volume.

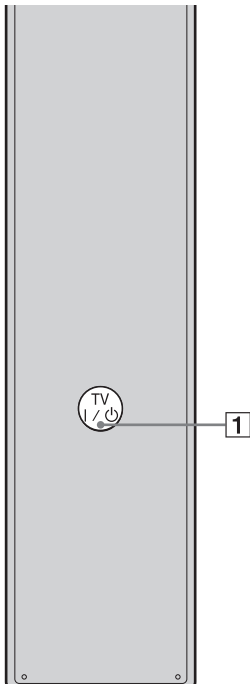

Rear of Remote Control

Selecting various functions and settings (Home Menu)

You can select all the features from the Home menu.
See page 17 for the Home menu map.

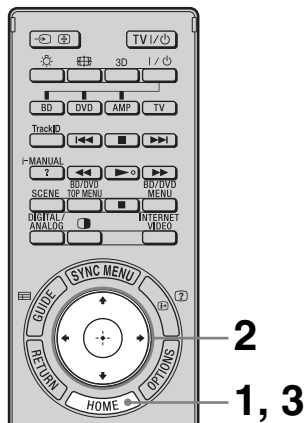

1 Press HOME.



2 Press $\uparrow/\downarrow/\leftarrow/\rightarrow/\oplus$ to select items.

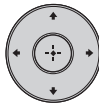

To select items in the Home menu (e.g., selecting “Settings”)

① Press \leftarrow/\rightarrow to select “Settings”.

The contents of “Settings” are displayed on the right.

② Press \uparrow/\downarrow to select “Display”.

③ Press \oplus to launch the menu.





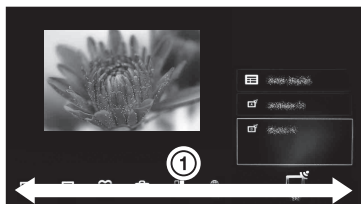





According to the screen instruction, press $\uparrow/\downarrow/\leftarrow/\rightarrow$ to select items and press \oplus to confirm.

3 Press HOME to exit.



Home menu map

After pressing **HOME** on the remote control, following icons are displayed as categories. The categories are available depending on your TV model, region, country and broadcasting conditions.

	TV	You can select a list of TV channels, or a programme guide.
	Media	You can enjoy photo/music/video content via USB devices or the home network.
	Inputs	You can select equipment connected to the TV.
	Favourites/History	Provides quick access to your frequently used and recently viewed items, such as TV channels, external inputs or your media files.
	Settings	Contains all of the necessary configurations to customise your TV settings.
	Widgets	Provides access to Widgets.
	Applications	You can enjoy various applications such as “Music Search”, “Internet Browser”, etc.
	Qriocity	Provides access to the “Qriocity” online service.
	Internet Content	You can enjoy Internet content services.
	Recommendations	Presents recommendations for programmes you may like, based on your viewing history.

Displaying Operating Instructions (i-Manual)

Operating instructions are built into your BRAVIA TV and can be displayed on the screen. To learn more about your TV's features, access your i-Manual with the touch of a button.

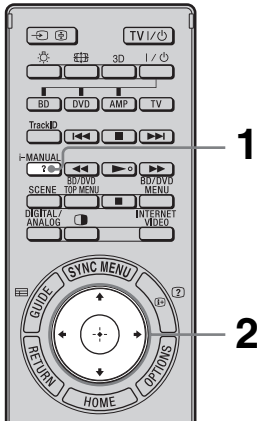

1 Press i-MANUAL.



2 Press $\uparrow/\downarrow/\leftarrow/\rightarrow/\oplus$ to select items.

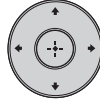

To select items in the i-Manual

- 1 Press \uparrow/\downarrow to select an item.

The contents in the item are displayed on the right as the second layer.

- 2 Press \rightarrow to move to the second layer.

- 3 Press \uparrow/\downarrow to select an item from the second layer.

A digest of the item is displayed on the right. If the third layer is available, repeat this step to display the digest of the item.

- 4 Press \rightarrow to select an item.

The content is displayed.

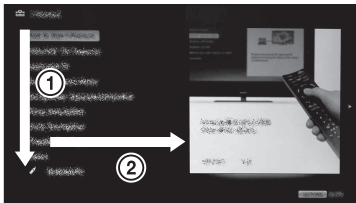

Description of the i-Manual screen

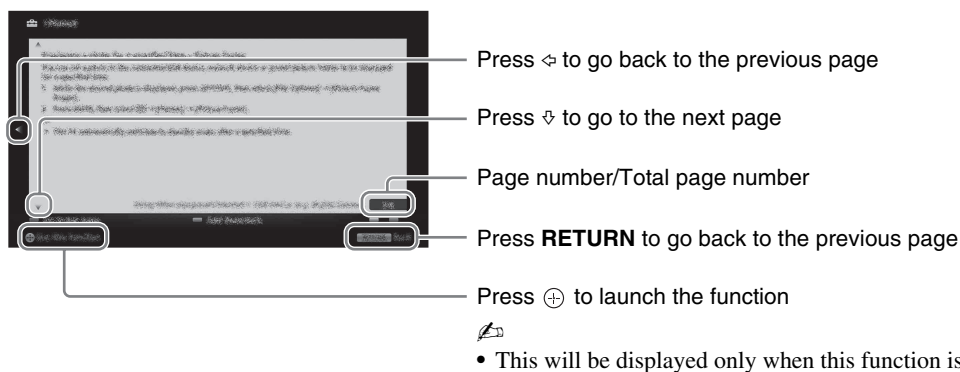

To use the bookmark

The i-Manual has a bookmark function. Pages can be bookmarked with coloured buttons, according to the instructions at the bottom of the screen. To access your registered bookmarks, go to the top page of the i-Manual and select “Bookmarks”.

To memorise the last displayed page

i-Manual memorises the last displayed page. When in the i-Manual screen, press **i-MANUAL** to return to the TV screen. If you press **i-MANUAL** again, the information you saw last time appears. For viewing from the top page of the i-Manual, return to the top page according to the instructions on screen, or press **HOME** and select “i-Manual” of “Settings” in the Home menu.

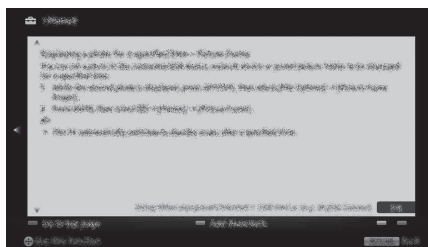

- Last page memory is automatically reset when you switch the TV to standby mode.

Network Setup

When you connect this TV to the Internet, you can enjoy multiple functions: displaying a photograph that shows its location on the map, enjoying Internet video, etc. For details on the functions, refer to the i-Manual.



- You will need to contract with an Internet service provider to connect to the Internet.

Preparing a wired network

For KDL-65HX92x

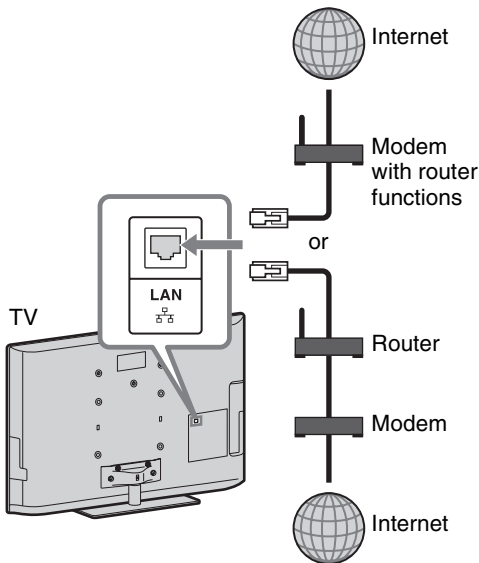

Except KDL-65HX92x

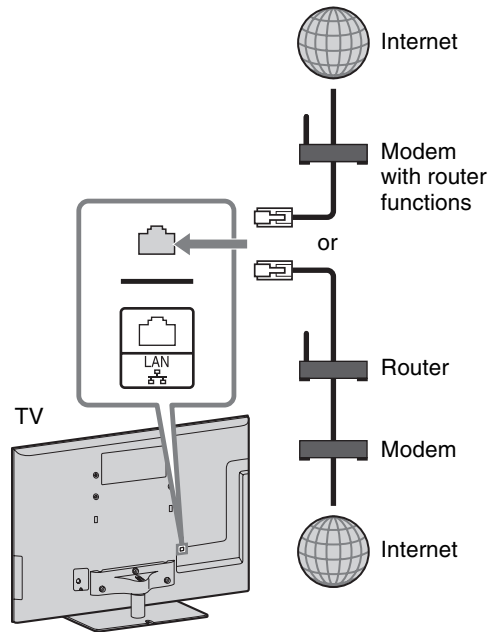

- For LAN connections, use a Category 7 cable (not supplied).

Preparing a wireless LAN

The built-in wireless LAN device allows you to access the Internet and your home network. With this feature, you can connect to a wireless LAN and enjoy the benefits of networking in a cable-free environment. Before setting up the wireless LAN function of the TV, be sure to set up a wireless LAN router.

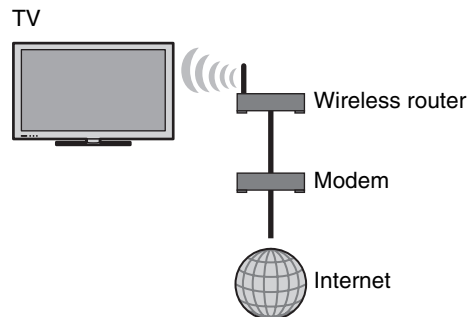

Setting up the Internet connection

Using the network feature you can connect the TV to the Internet. The set-up procedure differs depending on the type of network and LAN router. Before setting up the Internet connection, be sure to set up a LAN router. Check your wireless LAN environment using the following chart.

Wireless LAN

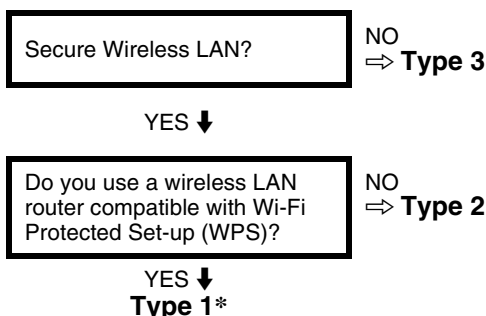

Wired LAN → Type 4

* Type 1 is easier to set up if your router has an automatic setting button, e.g. Air Station One-Touch Secure System (AOSS). Most of the latest routers have this function. Check your router.

Type 1: Follow the configuration for “Secured Network with Wi-Fi Protected Set-up (WPS)”.

Type 2: Follow the configuration for “Secured Network without Wi-Fi Protected Set-up (WPS)”.



Type 3: Follow the configuration for “Unsecured Network with Any Type of Wireless LAN Router”.

Type 4: Follow the configuration for “Wired network set-up”.

Type 1: Secured network with Wi-Fi protected Set-up (WPS)



The WPS standard makes security of a wireless home network as straightforward as pressing the WPS button on the wireless LAN router. Before setting up a wireless LAN, check the location of the WPS button on the router and verify how to use it.

For security purpose, “WPS (PIN)” provides a PIN code for your router. PIN code is renewed every time you select “WPS (PIN)”.

- 1** Press **HOME**, then select  > “Network” > “Network Set-up”.
- 2** Select “Wireless Set-up”.
- 3** Select “WPS (Push Button)” for Push Button method or “WPS (PIN)” for PIN method.
 - 
 - Button name of the WPS may differ depending on the router (e.g. AOSS button).
- 4** Follow the instructions on the set-up screen.

Type 2: Secured network without Wi-Fi protected Set-up (WPS)

To set up a wireless LAN, SSID (wireless network name) and security key (WEP or WPA key) will be required. If you do not know them, consult the instruction manual of your router.

- 1** Press **HOME**, then select  > “Network” > “Network Set-up”.
- 2** Select “Wireless Set-up”.
- 3** Select “Scan”, then select a network from the list of scanned wireless networks.
- 4** Follow the instructions on the set-up screen.
 - 
 - If you use WPS for network set-up, the security settings of the wireless LAN router activate, and any equipment previously connected to the wireless LAN in a non-secure status will be disconnected from the network.
 - In this case, activate the security settings of the disconnected equipment and then reconnect. Or, you can deactivate the security settings of the wireless LAN router, and then connect the equipment to a TV in a non-secure status.

Type 3: Unsecured network with any type of wireless LAN router

To set up a wireless LAN, SSID (wireless network name) will be required.

- 1 Press **HOME**, then select  > “Network” > “Network Set-up”.
- 2 Select “Wireless Set-up”.
- 3 Select “Scan”, then select a network from the list of scanned wireless networks.
- 4 Follow the instructions on the set-up screen.



- Security key (WEP or WPA key) will not be required because you do not need to select any security method in this procedure.

Type 4: Wired network set-up

Enter the respective alphanumeric values for your router if necessary. The items that need to be set (e.g. IP Address, Subnet Mask, DHCP) may differ depending on the Internet service provider or router. For details, refer to the instruction manuals provided by your Internet service provider, or those supplied with the router.

- 1 Press **HOME**, then select  > “Network” > “Network Set-up”.
- 2 Select “Wired Set-up”.
- 3 Select “Auto” to set the IP Address and proxy server automatically, or “Custom” to set them manually.
- 4 Follow the instructions on the set-up screen.

Viewing the network status

You can confirm your network status.

- 1 Press **HOME**, then select  > “Network” > “Network Set-up”.
- 2 Select “View Network Status”.

If you cannot connect to the Internet

Use the diagnosis to check possible causes for network connection failures, and settings.

- 1 Press **HOME**, then select  > “Network” > “Network Set-up”.
- 2 Select “View Network Status”.
- 3 Select “Check Connection”.

This may take several minutes. You cannot cancel the diagnosis after selecting “Check Connection”.

Adjusting the server display settings

You can select home network servers to be displayed on the Home Menu. Up to 10 servers can be displayed in the Home Menu automatically.

- 1 Press **HOME**, then select  > “Network” > “Home Network Setup”.
- 2 Select “Server Display Settings”.
- 3 Select the server you want to display on the Home Menu, and adjust the settings.

If you cannot connect to your home network

The TV detects if the server is being correctly recognised when you cannot connect it to your home network. If the diagnostic results indicate a failure, check possible causes, and network connections and settings.

1 Press **HOME**, then select  > “Network” > “Home Network Setup”.

2 Select “Server Diagnostics”.

The server diagnostic starts. When the server diagnostic is complete, the diagnostic result list appears.

Additional Information

Troubleshooting

When the ⏻ (standby) indicator is flashing, count how many times it flashes (interval time is three seconds).























Press ⏻ on the TV to turn it off, disconnect the AC power cord, and inform your dealer or Sony service centre of how the indicator flashes (number of flashes).

When the ⏻ (standby) indicator is not flashing, check the items in the table as follows.

Also refer to “Troubleshooting” in the i-Manual. If the problem persists, have your TV serviced by qualified service personnel.

Condition	Explanation/Solution
There is no picture (screen is dark) and no sound.	<ul style="list-style-type: none">• Check the antenna/cable connection.• Connect the TV to the AC power and press ⏻ on the TV.• If the ⏻ (standby) indicator lights up in red, press I/⏻.
Tiny black points and/or bright points appear on the screen.	<ul style="list-style-type: none">• The screen is composed of pixels. Tiny black points and/or bright points (pixels) on the screen do not indicate a malfunction.
Some programmes cannot be tuned.	<ul style="list-style-type: none">• Check the antenna or dish.
The TV's power cannot be turned on.	<ul style="list-style-type: none">• Check if ENERGY SAVING switch is on (●).
The TV turns off automatically (the TV enters standby mode).	<ul style="list-style-type: none">• Check if the “Sleep Timer” is activated, or confirm the “Duration” setting of “On Timer”.• Check if the “Idle TV Standby” is activated.• Check if “Presence Sensor” in “Eco” is activated. When no viewer is detected in front of the TV for a preset time, the picture automatically turns off, while leaving only the TV sound on. Additionally, after 30 minutes in picture off mode, the TV will switch to standby mode.
The remote does not function.	<ul style="list-style-type: none">• Replace the batteries.• Your TV may be in SYNC mode. Press SYNC MENU, select “TV Control” and then select “Home (Menu)” or “Options” to control the TV.
The “Parental Lock” password has been forgotten.	<ul style="list-style-type: none">• Enter 9999 for the PIN code. (PIN code 9999 is always accepted.)
The TV surrounds become warm.	<ul style="list-style-type: none">• When the TV is used for an extended period, the TV surrounds become warm. You may feel hot when touching there by the hand.

Specifications

System	
Panel system	LCD (Liquid Crystal Display) Panel
TV system	Analogue: B/G, I, D/K, M, L Digital: DVB-T
Colour/video system	Analogue: PAL, PAL60 (only video input), SECAM, NTSC3.58, NTSC4.43 (only video input) Digital: MPEG-2 MP@ML/HL, MPEG-2 MP@ML/HL, H.264/MPEG-4 AVC MP/HP@L4
Channel coverage	Analogue: VHF: E2–E12/UHF: E21–E69/CATV: S01–S03, S1–S41 VHF: 0–12, 5A, 9A/UHF: 28–69/CATV: S01–S03, S1–S44 (Australia) VHF: 1–11 (New Zealand) D/K: VHF: R1–R12, R21–R69/L: F2–F10, B–Q, F21–F69/I: UHF B21–B69/M: A2–A13, A14–A79 Digital: VHF/UHF, UHF (New Zealand only)
Sound output	10 W + 10 W + 10 W + 10 W (KDL-60NX72x) 10 W + 10 W + 10 W (except KDL-60NX72x)
Input/Output jacks	
Antenna/cable	75 ohm external terminal for VHF/UHF
  2 (for KDL-65HX92x)	 COMPONENT IN Supported formats: 1080p, 1080i, 720p, 576p, 576i, 480p, 480i  2 Video input (phono jacks)
 COMPONENT IN (for KDL-65HX92x)	Audio input (phono jacks)
   (except KDL-65HX92x)	 Video input (phono jacks)  COMPONENT IN Supported formats: 1080p, 1080i, 720p, 576p, 576i, 480p, 480i  Audio input (phono jacks)
HDMI IN1, 2, 3, 4	Video: 1080/24p/30p, 1080p, 1080i, 720/24p/30p, 720p, 576p, 576i, 480p, 480i Audio: Two channel linear PCM: 32, 44.1 and 48 kHz, 16, 20 and 24 bits, Dolby Digital  Analogue audio input (minijack) (HDMI IN4 only) ARC (Audio Return Channel) (HDMI IN 1 only) PC Input
 DIGITAL AUDIO OUT (OPTICAL)	Digital optical jack (Two channel linear PCM, Dolby Digital)
 AUDIO OUT / 	Audio output (stereo minijack) Headphones jack
 PC IN (for KDL-65HX92x) PC IN   (except KDL-65HX92x)	PC Input (Mini D-sub 15-pin)  PC audio input (minijack)
 1,  2	USB port
 LAN	10BASE-T/100BASE-TX connector (Depending on the operating environment of the network, connection speed may differ. 10BASE-T/100BASE-TX communication rate and communication quality are not guaranteed for this TV.)

Model name KDL-	65HX92x	60NX72x	55HX92x	55HX820	55NX72x	46HX92x	46HX820	46NX72x	40NX72x
Power and others									
Power requirements	110 V – 240 V AC, 50/60 Hz								
Screen size (measured diagonally)	Approx. 163.9 cm/ 65 inches	Approx. 152.5 cm/ 60 inches	Approx. 138.8 cm/55 inches			Approx. 116.8 cm/46 inches		Approx. 101.6 cm/ 40 inches	
Display resolution	1,920 dots (horizontal) × 1,080 lines (vertical)								
Power consumption	Indicated on the rear of the TV								
Dimensions (Approx.) (w × h × d)									
with Table-Top Stand (mm)	1504 × 935 × 374	1405 × 874 × 304	1278 × 803 × 308	1280 × 804 × 305	1281 × 805 × 308	1081 × 692 × 258	1083 × 693 × 255	1084 × 694 × 258	949 × 618 × 213
without Table-Top Stand (mm)	1504 × 900 × 45	1405 × 844 × 33	1278 × 771 × 38	1280 × 774 × 27	1281 × 774 × 27	1081 × 660 × 38	1083 × 663 × 27	1084 × 663 × 27	949 × 587 × 27
Mass (Approx.)									
with Table-Top Stand (kg)	51.7	34.5	31.6	28.3	28.3	24.0	21.1	20.2	17.0
without Table-Top Stand (kg)	43.2	28.8	26.1	23.2	23.1	19.4	16.8	15.8	13.1
Supplied accessories	See “Checking the accessories” (page 8).								

Model name KDL-	65HX92x	60NX72x	55HX92x	55HX820	55NX72x	46HX92x	46HX820	46NX72x	40NX72x
Optional accessories	Wall-Mount Bracket: SU-WL50B SU-WL700 (except KDL-65HX92x, KDL-60NX72x) Wall-Hanging Bracket: SU-WH500 (except KDL-65HX92x) USB Wireless LAN Adaptor 3D Glasses: TDG-BR250, TDG-BR200, TDG-BR100, TDG-BR50 Camera and Microphone Unit: CMU-BR100 (except KDL-60/55/46/40NX723, KDL-65/55/46HX923) TV Stand* : SU-B551S (KDL-55HX92x, KDL-55HX820, KDL-55NX72x) SU-B461S (KDL-46HX92x, KDL-46HX820, KDL-46NX72x) SU-B401S (KDL-40NX72x)								
Operating temperature	0 °C – 40 °C								
Operating humidity	10 % – 80 % RH (non-condensing)								

* TV Stand may not be available depending on your region/country.

Design and specifications are subject to change without notice.

Installing the Accessories (Wall-Mount/Wall-Hanging Bracket)

To Customers:

For product protection and safety reasons, Sony strongly recommends that installing of your TV be performed by Sony dealers or licensed contractors. Do not attempt to install it yourself.

To Sony Dealers and Contractors:

Provide full attention to safety during the installation, periodic maintenance and examination of this product.

Your TV can be installed using the SU-WH500 (page 28) Wall-Hanging Bracket (sold separately) or SU-WL700 (page 28) or SU-WL50B (page 29) Wall-Mount Bracket (sold separately).

- Refer to the Instructions supplied with the Wall-Mount Bracket or Wall-Hanging Bracket to properly carry out the installation.
- Refer to “Detaching the Table-Top Stand from the TV” (page 9).

Sufficient expertise is required for installing this product, especially to determine the strength of the wall for withstanding the TV's weight. Be sure to entrust the attachment of this product to the wall to Sony dealers or licensed contractors and pay adequate attention to safety during the installation. Sony is not liable for any damage or injury caused by mishandling or improper installation.

When installing the TV on a wall, remove the screws from the rear of the TV. The screws and number of screws are available depending on the TV model (They are fastened in the screw holes for wall mounting.) Be sure to store the removed screws in a safe place, keeping them away from children.

SU-WH500

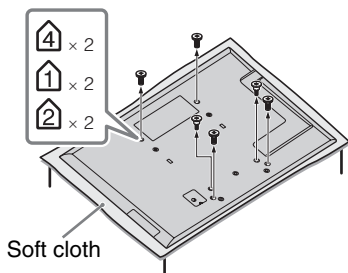

SU-WL700 or SU-WL50B

► For KDL-65HX92x

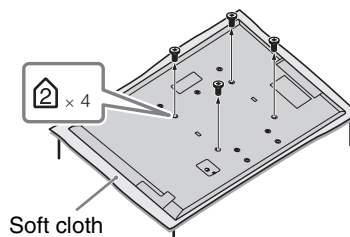

► Except KDL-65HX92x

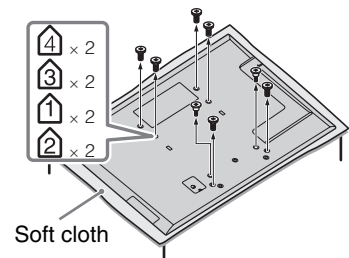

- When removing the Table-Top Stand from the TV, lay the display face down on a stable work surface that is larger than the TV.
- To prevent damaging the surface of the LCD display, make sure to place a soft cloth on the work surface.

SU-WH500 (except KDL-65HX92x)

Refer to the Instructions supplied with the SU-WH500 Wall-Hanging Bracket to properly carry out the installation.

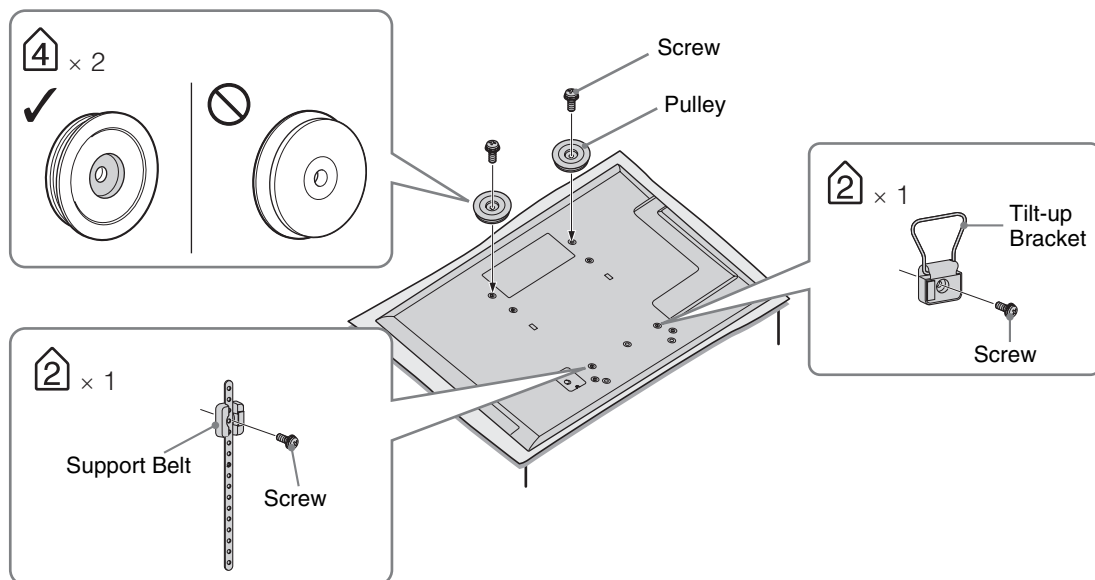

- With the screen of the TV facing down, attach the SU-WH500 accessories.
- It is unnecessary to attach the Cushions supplied with SU-WH500. (**3**-1 in “Installation” of SU-WH500 Instructions)
- Attach the Pulleys to the upper two screw holes (see illustration) using screws supplied with SU-WH500. (**3**-3 in “Installation” of SU-WH500 Instructions)
- Attach the Tilt-up Bracket and the Support Belt (see illustration) using screws supplied with SU-WH500. (**3**-4, 5 in “Installation” of SU-WH500 Instructions)

SU-WL700 (except KDL-65HX92x, KDL-60NX72x)

Precautions

Be sure to install the Wall-Mount Bracket securely to the wall following the instructions in this as well as the manual provided with the Wall-Mount Bracket. The numbers given in the parentheses indicate the installation steps described in the instruction manual provided with Wall-Mount Bracket.

- 1** Check the parts supplied with the Wall-Mount Bracket (**1**).
Refer to the instruction manual provided with the Wall-Mount Bracket.
- 2** Decide on the installation location. (**2**-1)
Refer to the following “TV installation dimensions table”. Allow for suitable clearance between the TV, the ceiling and protruding parts of the wall as instructed.
- 3** Install the Base Bracket on the wall. (**2**-2 through **3**)
Decide the positions of the screw on the wall and install the Base Bracket. Refer to the instruction manual provided with the Wall-Mount Bracket for details.
- 4** Detach the Table-Top Stand from the TV, if necessary. (**4**-1)

 - See “Detaching the Table-Top Stand from the TV” (page 9) for details.

5 Attach the Mounting Bracket and the Lock Bracket. (**4**-3 through **4**-7)

Refer to the instruction manual provided with the Wall-Mount Bracket.

6 Prepare the paper template. (**5**-2)

1. Refer to the following “TV installation dimensions table” and mark the TV outline on the template.

2. Tape the template to the wall as instructed in the manual provided with the Wall-Mount Bracket. Follow the instruction manual provided with the Wall-Mount Bracket to complete the installation.

(**5**-3 through **6**)

SU-WL50B

For KDL-65HX92x

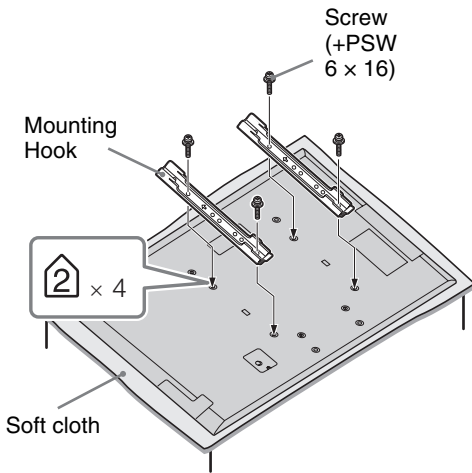

Except KDL-65HX92x

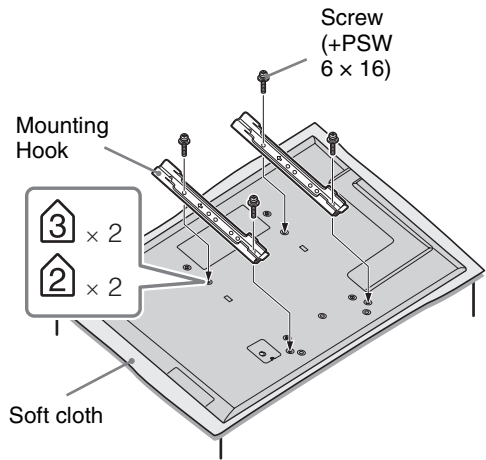

- Attach the Mounting Hook using four screws supplied with the Wall-Mount Bracket.
- When attaching the Table-Top Stand again, be sure to fasten the screws (previously removed) to the original holes on the rear of the TV.

Screw and Hook locations diagram/table

Model Name KDL-	Screw location	Hook location
	SU-WL50B	SU-WL50B
65HX92x	d, i	a
60NX72x		
55HX92x/55HX820/55NX72x	e, j	b
46HX92x/46HX820/46NX72x		
40NX72x		

SU-WL50B

Screw location

When installing the Mounting Hook on the TV.

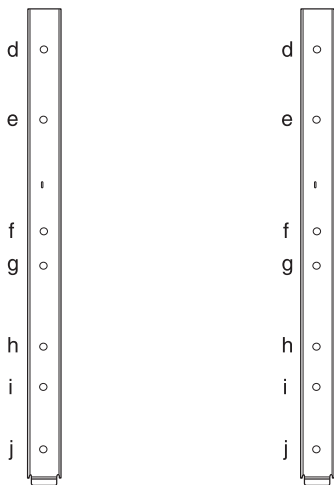

Hook location

When installing the TV onto the Base Bracket.

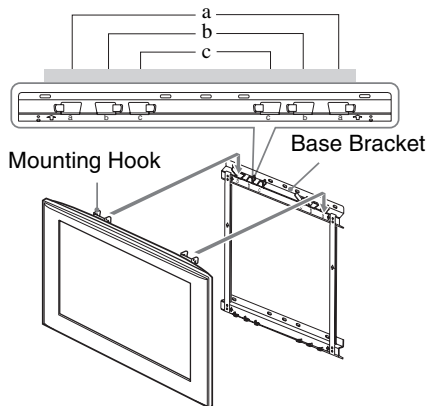

TV installation dimensions table

① SU-WH500

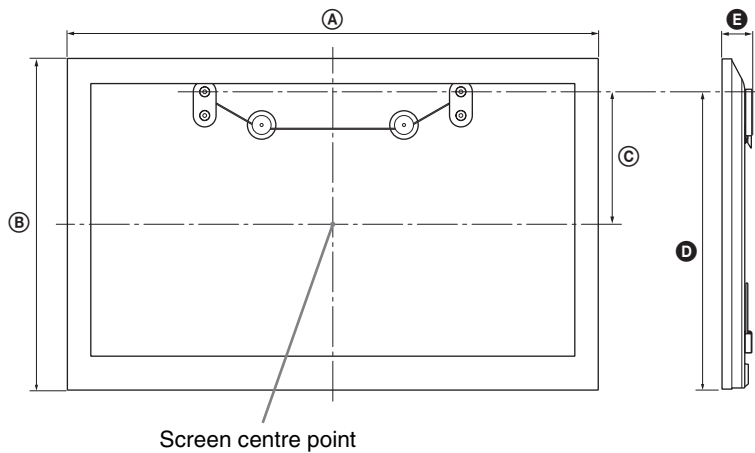

② SU-WL700

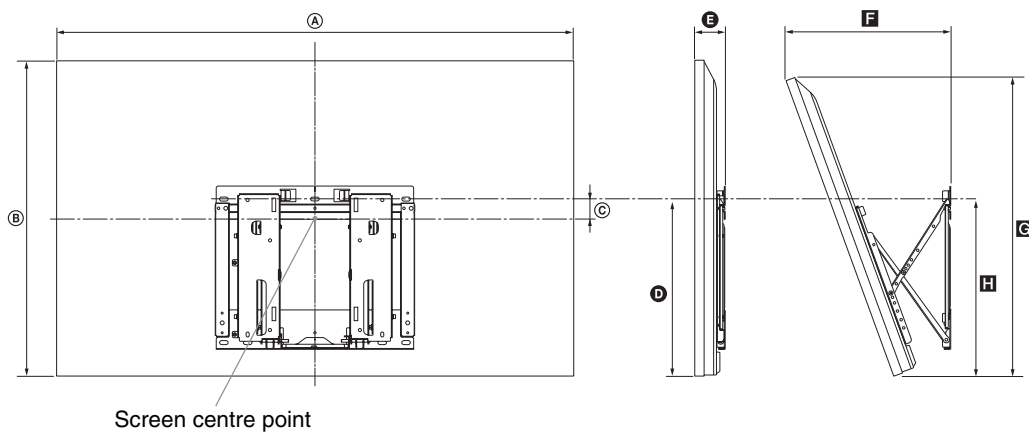

③ SU-WL50B

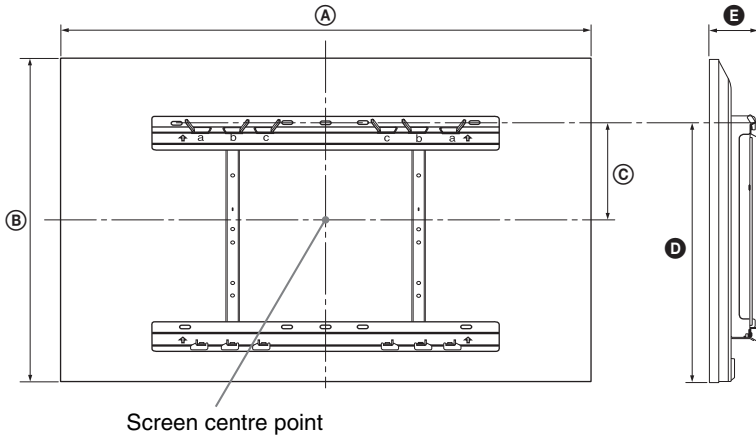

Unit: mm

Model Name KDL-	Display dimensions		Screen centre dimension			Length for each mounting angle										
						Angle (0°)						Angle (20°)				
	A	B	C			D			E			F	G	H		
			SU-WH500	SU-WL700	SU-WL50B	SU-WH500	SU-WL700	SU-WL50B	SU-WH500	SU-WL700	SU-WL50B	SU-WL700				
65HX92x	1504	900			53			514			107					
60NX72x	1405	844	327		82	761		516	43		89					
55HX92x	1278	771	299	5	93	696	393	490	52	58	99	376	728	455		
55HX820	1280	774	297	5	93	695	395	492	41	47	87	366	729	453		
55NX72x	1281	774	297	5	93	695	395	491	41	47	87	366	729	452		
46HX92x	1081	660	243	51	148	585	393	490	52	58	98	338	623	455		
46HX820	1083	663	242	51	148	586	395	491	41	47	87	328	625	453		
46NX72x	1084	663	242	51	148	586	395	492	41	47	87	328	625	452		
40NX72x	949	587	205	103	185	511	395	491	41	47	87	302	554	452		

Figures in the table may differ slightly depending on the installation.

WARNING

The wall that the TV will be installed should be capable of supporting a weight of at least four times that of the TV. Refer to “Specifications” (page 25) for its weight.

Safety Information

Installation/Set-up

Install and use the TV set in accordance with the instructions below in order to avoid any risk of fire, electrical shock or damage and/or injuries.

Installation

- The TV set should be installed near an easily accessible AC power outlet.
- Place the TV set on a stable, level surface to avoid it from falling down and cause personal injury or damage to the TV.
- Only qualified service personnel should carry out wall installations.
- For safety reasons, it is strongly recommended that you use Sony accessories, including:
 - Wall-Hanging Bracket SU-WH500 (except KDL-65HX92x)
 - Wall-mount bracket SU-WL700 (except KDL-65HX92x, KDL-60NX72x) SU-WL50B
- Be sure to use the screws supplied with the Wall-mount bracket when attaching the mounting hooks to the TV set. The supplied screws are designed so that they are 8 mm to 12 mm in length when measured from the attaching surface of the mounting hook. The diameter and length of the screws differ depending on the Wall-mount bracket model. Use of screws other than those supplied may result in internal damage to the TV set or cause it to fall, etc.

8 mm - 12 mm

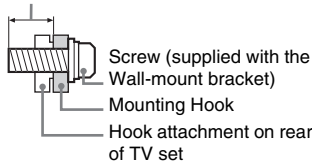

Transporting

- Before transporting the TV set, disconnect all cables.
- Two or more people are needed to transport a large TV set.
- When transporting the TV set by hand, hold it as shown below. Do not put stress on the LCD panel and the frame around the screen.



KDL-65HX92x

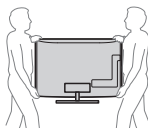

KDL-60/55/46/40NX72x/
KDL-55/46HX92x/
KDL-55/46HX820

- When transporting the TV set, do not subject it to jolts or excessive vibration.
- When transporting the TV set for repairs or when moving, pack it using the original carton and packing material.

Ventilation

- Never cover the ventilation holes or insert anything in the cabinet.
- Leave space around the TV set as shown below.
- It is strongly recommended that you use a Sony wall-mount bracket in order to provide adequate air-circulation.

Installed on the wall

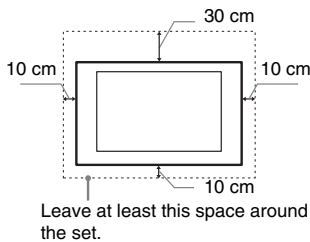

Leave at least this space around the set.

Installed with stand

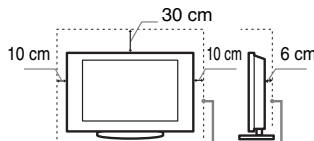

Leave at least this space around the set.

- To ensure proper ventilation and prevent the collection of dirt or dust:
 - Do not lay the TV set flat, install upside down, backwards, or sideways.
 - Do not place the TV set on a shelf, rug, bed or in a closet.
 - Do not cover the TV set with a cloth, such as curtains, or items such as newspapers, etc.
 - Do not install the TV set as shown below.

Air circulation is blocked.

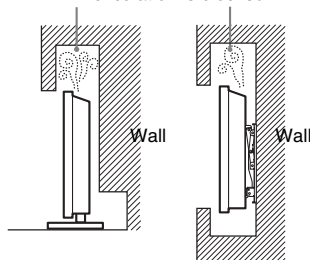

AC power cord

Handle the AC power cord and outlet as follows in order to avoid any risk of fire, electrical shock or damage and/or injuries:

- Use only Sony supplied AC power cords, not those of other brands.
- Insert the plug fully into the AC power outlet.
- Operate the TV set on a 110–240 V AC supply only.
- When wiring cables, be sure to unplug the AC power cord for your safety and take care not to catch your feet on the cables.
- Disconnect the AC power cord from the AC power outlet before working on or moving the TV set.
- Keep the AC power cord away from heat sources.
- Unplug the AC power plug and clean it regularly. If the plug is covered with dust and it picks up moisture, its insulation may deteriorate, which could result in a fire.

Notes

- Do not use the supplied AC power cord on any other equipment.
- Do not pinch, bend, or twist the AC power cord excessively. The core conductors may be exposed or broken.
- Do not modify the AC power cord.
- Do not put anything heavy on the AC power cord.
- Do not pull on the AC power cord itself when disconnecting the AC power cord.
- Do not connect too many appliances to the same AC power outlet.
- Do not use a poor fitting AC power outlet.

Prohibited Usage

Do not install/use the TV set in locations, environments or situations such as those listed below, or the TV set may malfunction and cause a fire, electrical shock, damage and/or injuries.

Location:

- Outdoors (in direct sunlight), at the seashore, on a ship or other vessel, inside a vehicle, in medical institutions, unstable locations, near water, rain, moisture or smoke.
- If the TV is placed in the changing room of a public bath or hot spring, the TV may be damaged by airborne sulfur, etc.



- For best picture quality, do not expose the screen to direct illumination or sunlight.
- Avoid moving the TV from a cold area to a warm area. Sudden room temperature changes may cause moisture condensation. This may cause the TV to show poor picture and/or poor colour. Should this occur, allow moisture to evaporate completely before powering the TV on.
- Never spray water or detergent directly on the TV set. It may drip to the bottom of the screen or exterior parts and enter the TV set, and may cause damage to the TV set.



Environment:

- Places that are hot, humid, or excessively dusty; where insects may enter; where it might be exposed to mechanical vibration, near flammable objects (candles, etc). The TV set shall not be exposed to dripping or splashing and no objects filled with liquids, such as vases, shall be placed on the TV.
- Do not place the TV in a humid or dusty space, or in a room with oily smoke or steam (near cooking tables or humidifiers). Fire, electric shock, or warping may result.



- Do not install the TV in places subject to extreme temperature, such as in direct sunlight, near a radiator or a heating vent. The TV may overheat in such conditions which can cause deformation of the enclosure and/or TV malfunction.

**Situation:**

- Do not use when your hands are wet, with the cabinet removed, or with attachments not recommended by the manufacturer. Disconnect the TV set from AC power outlet and antenna during lightning storms.
- Do not install the TV so that it sticks out into an open space. Injury or damage from a person or object bumping into the TV may result.

**Broken pieces:**

- Do not throw anything at the TV set. The screen glass may break by the impact and cause serious injury.
- If the surface of the TV set cracks, do not touch it until you have unplugged the AC power cord. Otherwise electric shock may result.

When not in use

- If you will not be using the TV set for several days, the TV set should be disconnected from the AC power for environmental and safety reasons.
- As the TV set is not disconnected from the AC power when the TV set is just turned off, pull the plug from the AC power outlet to disconnect the TV set completely.
- However, some TV sets may have features that require the TV set to be left in standby to work correctly.

For children

- Do not allow children to climb on the TV set.
- Keep small accessories out of the reach of children, so that they are not mistakenly swallowed.

If the following problems occur...

Turn off the TV set and unplug the AC power cord immediately if any of the following problems occur.

Ask your dealer or Sony service centre to have it checked by qualified service personnel.

When:

- AC power cord is damaged.
- Poor fitting of AC power outlet.
- TV set is damaged by being dropped, hit or having something thrown at it.
- Any liquid or solid object falls through openings in the cabinet.

Instructions about "Installing Wall Mount Bracket" are included within this TV's instructions manual.



Customer Support:

<http://www.sony-asia.com/support>



* 4 2 6 8 2 6 7 1 6 * (1)

<http://www.sony.net/>

4-268-267-16(1)