

# SONY®

Interchangeable Lens  
Digital Camera

Instruction Manual

# Operations

E-mount

---

Parts and controls

---

Triple-dial-control

---

Custom key assignment

---

AF/MF button/AEL button

---

Others

α

NEX-7

# Table of contents

This [Operations] describes basic operation of the camera, and some advanced operations using the major functions. See [Getting Started] for information on how to set up the camera, and the [Handbook] on the CD-ROM (supplied) for more detailed functions and operations.

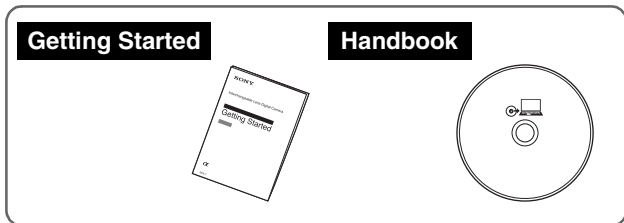

## **Operations** (This manual)

---

### **Parts and controls**

Recording .....	5
Playback .....	7
Setup .....	8

---

### **Triple-dial-control**

Triple-dial-control operation .....	10
Functions of the control dials .....	12
Settings modes available .....	13

---

### **Custom key assignment**

Assigning the functions to the custom keys .....	22
Functions that can be assigned .....	23

---

### **AF/MF button/AEL button**

Switching the focusing mode with the AF/MF button .....	27
Locking the AE with AEL button .....	28

---

## Others

Menu list.....	30
The unique digital shooting functions.....	39
α Handbook.....	42
Restriction of the functions .....	43
Number of recordable images.....	46
List of icons on the screen.....	49
Troubleshooting .....	52
Specifications .....	53
Index.....	56

## **Parts and controls**

All the major parts of your camera, and controls and buttons that are used for recording, playback, and setups are described here.

# Recording

## Navigation button

Selects the adjustment settings for the Triple-dial-control operation.

## Control dial R

Sets the items that appear at the top right of the screen.

## Control dial L

Sets the items that appear at the top left of the screen.

## Shutter button

Shoots still images.  
Allows you to focus on the subject when it is pressed half way down.

## Zoom ring

Zooms in or out the subject (when a zoom lens is used).

## ON/OFF (Power) switch

Turns on the camera at ON, off the camera at OFF.

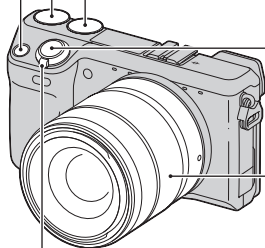

### **(Flash pop-up) button\***

Pops up the built-in flash.

Press the button when you want to fire the flash.  
Push the flash down to retract it when you do not want to fire the flash (page 44).

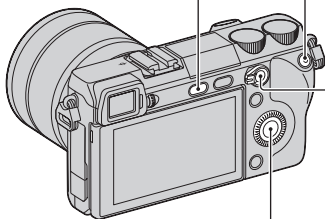

### **MOVIE button**

Records movies.  
Pressing this button again stops recording (page 41).

### **AF/MF button/AEL button**

At AF/MF, the focusing mode switches between auto and manual while the button is held down (page 27).  
At AEL, AE is locked while the button is held down (page 28).

### **button**

Selects the drive mode.

### **DISP button**

Switches the screen display.

### **Control wheel**

Sets the items that appear to the right of the screen. Turn the control wheel.

### **button**

Compensates for the exposure.

\* Be careful as the flash pops up when you press the button. Retract the flash when you are not using it. Be careful not to pinch your finger when you push the flash down.

# Playback

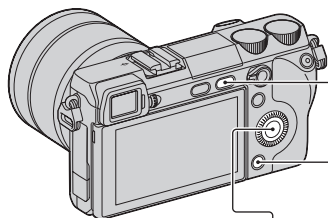

## ▶ (Playback) button

Switches between the shooting mode and the playback mode.

## 🗑️ (Delete) button

Deletes the image when 🗑️ is displayed at the lower right corner of the screen.

## DISP button

Switches the screen display.

## Control wheel

Selects the image.

## 📐 button

Displays the image index.

## ⏏ (Enlarge Image) button

Enlarges the image on the screen when it is pressed while ⏏ is displayed at the center on the right side of the screen. Turning the control wheel adjusts the scaling.

# Setup

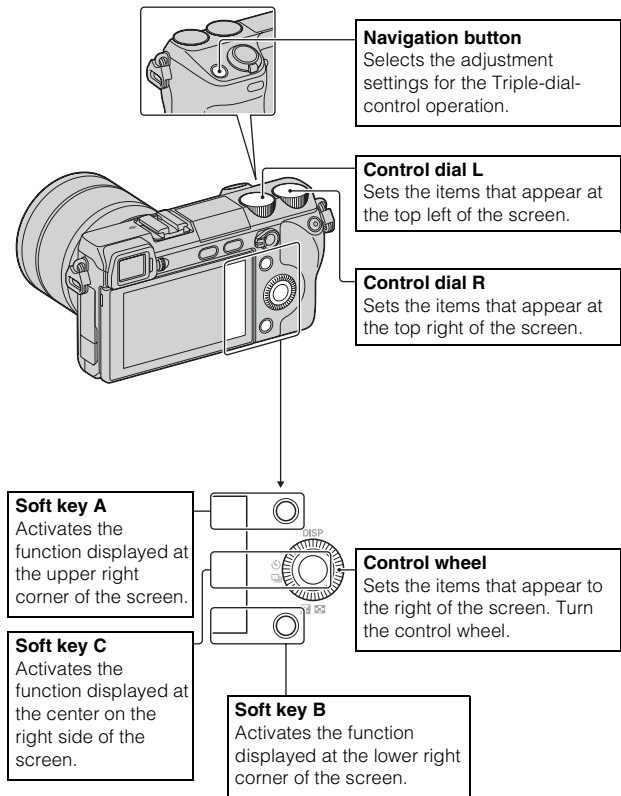



## **Triple-dial-control**

The Triple-dial-control allows you to adjust the various shooting settings quickly and intuitively, using the 3 dials and the Navigation button.

## Triple-dial-control operation

The Triple-dial-control allows you to adjust or set various shooting adjustment items, simultaneously, on a single screen.

Even though you can set these functions separately on the menu screen, using the Triple-dial-control, you can adjust these functions interactively on the same screen.

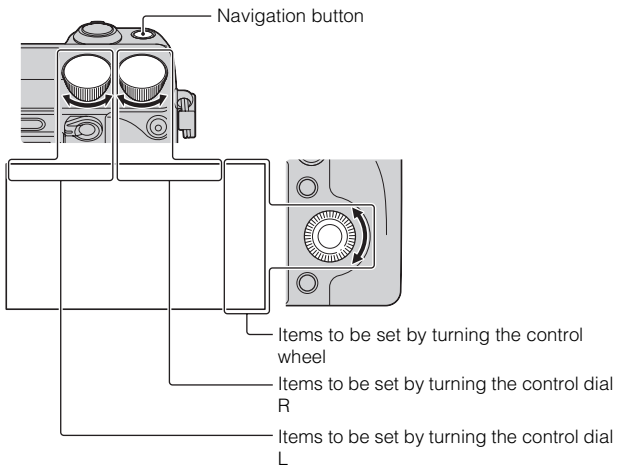

- 1 Press the center of the control wheel, and turn it to select a shooting mode from P, A, S, or M.

When [Soft key C Setting] is set to [Custom], select a shooting mode by MENU → [Shoot Mode].

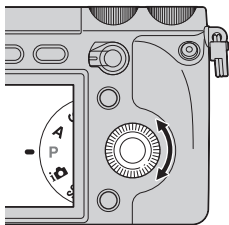

- 2 Press the Navigation button to select the desired settings.

- 
- 3** Set each settings by turning the control dials L/R and the control wheel.
- 

### Navigation button

Each time you press the button, the item toggles as follows.

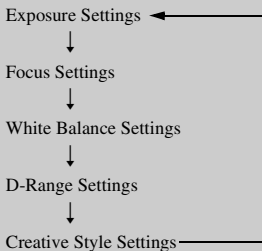

In addition, [Picture Effect Settings] and [Custom Settings] are available. You can select the settings you want to use by selecting MENU → [Setup] → [Function Settings].

The Exposure Settings is permanent and cannot be altered.

## Preventing the dials from operating incorrectly

You can lock the control dials L/R and the control wheel.

---

- 1** Hold the Navigation button down.

To unlock them, hold the Navigation button down again.

You can set to lock the control wheel only, or not to lock any of them by selecting MENU → [Setup] → [Dial/Wheel Lock].

---

## Functions of the control dials

The control dials and the control wheel have different tasks, depending on the “Settings” currently in effect.

See “Settings modes available” (pages 13 to 20) for more details.

	Control dial L	Control dial R	Control wheel
Exposure Settings*	Shutter speed/ Aperture/Program shift	Aperture/ Exposure compensation	ISO
Focus Settings (AF mode)	Focus area	Flexible spot position (right/ left)	Flexible spot position (up/ down)
Focus Settings (MF mode)	Enlarging position (up/down)	Enlarging position (right/left)	Enlarging position (up/down)
White Balance Settings	Mode/Color temperature	Color temperature (B-A)	Color temperature (G-M)
D-Range Settings	DRO level/HDR level	Exposure compensation	Mode
Creative Style Settings	Mode	Option	Option
Picture Effect Settings**	Mode	Option	–
Custom Settings**	Custom Settings 1 mode	Custom Settings 2 mode	Custom Settings 3 mode

\* Permanent item

\*\* This item cannot be selected in the default setting. You can add it by MENU → [Setup] → [Function Settings].

# Settings modes available

What you can set with each Settings mode are described here.

✔ indicates the default setting.



## Exposure Settings

Shooting mode	Control dial L	Control dial R	Control wheel
Manual Exposure	Shutter speed	Aperture	ISO
Shutter Priority	Shutter speed	Exposure compensation	ISO
Aperture Priority	Aperture	Exposure compensation	ISO
Program Auto	Program shift	Exposure compensation	ISO

- You can set the exposure compensation by turning the control dial R when [Anti Motion Blur], [Sweep Panorama], or [3D Sweep Panorama] is selected.

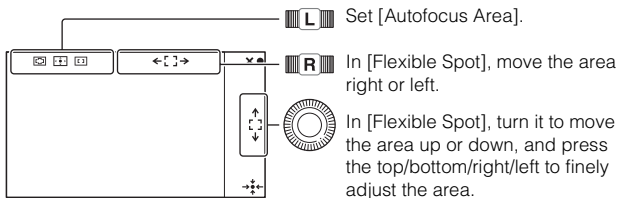
## Focus Settings (AF mode)



Control dial L		
✓	 (Multi)	The camera uses the 25 AF areas and focuses automatically. <ul style="list-style-type: none"> <li>• When the Face Detection function is active, AF operates with priority on faces.</li> </ul>
	 (Center)	The camera uses the AF area located in the center area exclusively.
	 (Flexible Spot)	Moves the focusing area to focus on a small subject or narrow area. Press soft key B to bring the focusing area back to the center.

## Focus Settings (MF mode)



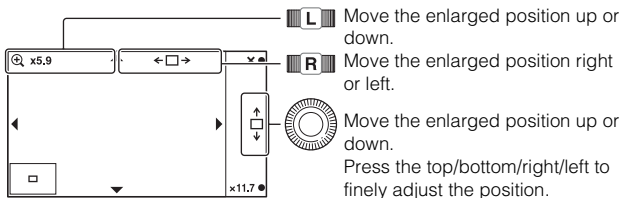





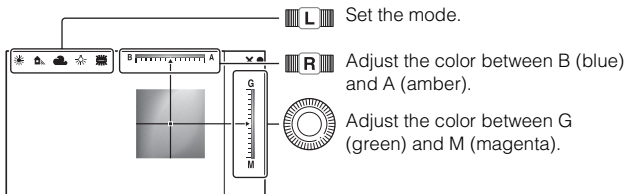

You can set the enlarged position for manual focusing.



You can adjust the scaling with soft key B or C.

## White Balance Settings



Control dial L		
✓	AWB (Auto WB)	The camera automatically detects a light source and adjusts the color temperature.
	 (Daylight)	If you select an option to suit a specific light source, the color temperature is adjusted for the light source (preset white balance).
	 (Shade)	
	 (Cloudy)	
	 (Incandescent)	
	 -1 (Fluor.: Warm White)	
	 0 (Fluor.: Cool White)	
	 +1 (Fluor.: Day White)	
	 +2 (Fluor.: Daylight)	
	 (Flash)	
	 (C.Temp./Filter)	Adjusts the color temperature depending on the light source. Achieves the effect of CC (Color Compensation) filters for photography. To select a color temperature, press soft key B followed by turning the control dial L.
	 (Custom)	Allows to use the white balance setting retained by [Custom Setup].



### Setting the custom white balance

Selecting [Custom] with the control dial L and pressing soft key B will display the [Custom Setup] screen. Hold the camera so that the white area fully covers the AF area located in the center, and then press the shutter button down. The calibrated values are stored for later use.

## D-Range Settings

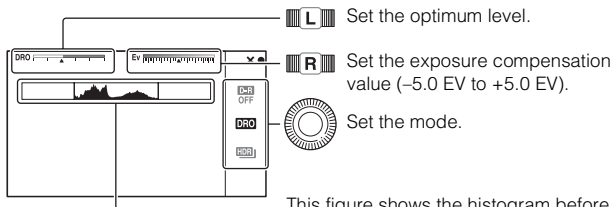

This figure shows the histogram before the D-Range Optimizer or the Auto HDR was applied, not that of the image that will actually be shot.

Control wheel		
	<b>D-R OFF</b> (Off)	Does not use [DRO/Auto HDR].
✓	<b>DRO</b> (D-Range Opt.)	By dividing the image into small areas, the camera analyzes the contrast of light and shadow between the subject and the background, producing the image with the optimal brightness and gradation.
	<b>HDR</b> (Auto HDR)	Shoots 3 images with different exposures, and then overlays the bright area of the under exposed image and the dark area of the over exposed image to create an image with rich gradation. 1 image with proper exposure and 1 overlaid image are recorded.
Control dial L		
	AUTO, Lv1 – Lv5 (D-Range Opt.)	Using the D-Range Optimizer, optimizes the gradations of a recorded image in each area of the image. Select the optimal level between Lv1 (weak) and Lv5 (strong). Automatically adjusted at [AUTO].
	AUTO, 1.0 EV – 6.0 EV (Auto HDR)	Using the Auto HDR, sets the exposure difference, based on the contrast of the subject. Select the optimal level between 1.0 EV (weak) and 6.0 EV (strong). Automatically adjusted at [AUTO].





## To use the D-Range Settings effectively

By combining the DRO/Auto HDR manual setting (exposure difference/ DRO-Level) and the exposure compensation, you can control the range of the contrast of light and shadow (gradations) to be reproduced.







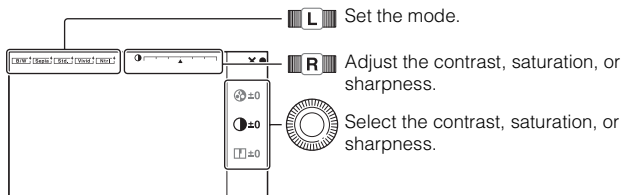





With DRO, set a DRO-Level to reproduce the shadow side, and set a minus value of exposure compensation to reproduce the light side. A large minus compensation and DRO-Level setting may cause noise. It is recommended that you check the result first, by enlarging the playback image, etc.

With Auto HDR, set the exposure difference to adjust the overall reproduction range, and shift the range towards light side (minus compensation) or shadow side (plus compensation) with the exposure compensation.

## Creative Style Settings





Control dial L		
✓	<b>Std.</b> ↑ (Standard)	For shooting various scenes with rich gradation and beautiful colors.
	<b>Vivid</b> ↑ (Vivid)	The saturation and contrast are heightened for shooting striking images of colorful scenes and subjects such as flowers, spring greenery, blue sky, or ocean views.
	<b>Ntrl</b> ↑ (Neutral)	The saturation and sharpness are lowered for capturing images in a quiet tone. This is also suitable for capturing image material to be modified with a computer.

 (Clear)	For capturing images in a clear tone with limpid colors in the highlighted area, suitable for capturing radiant light.
 (Deep)	For capturing images with deep and dense color expressions, suited to capturing the solid presence of the subject.
 (Light)	For capturing images with bright and uncomplicated color expressions, suited to capturing refreshingly light ambience.
 (Portrait)	For shooting the skin color in a soft tone, ideally suited for shooting portraits.
 (Landscape)	The saturation, contrast, and sharpness are heightened for shooting vivid and crisp scenery. Distant landscapes also stand out more.
 (Sunset)	For shooting the beautiful red of the setting sun.
 (Night Scene)	The contrast is attenuated for capturing a nightscape that is more faithful to the real view.
 (Autumn leaves)	For capturing autumn scenes, vividly highlighting the red and yellow of coloring leaves.
 (Black & White)	For shooting images in black and white monotone.
 (Sepia)	For capturing images in sepia monotone.
<b>Control wheel</b>	
 (Contrast)	The higher the value selected, the more the difference of light and shadow is accentuated, thus making an impact on an image.
 (Saturation)	The higher the value selected, the more vivid the color. When a lower value is selected, the color of the image is restrained and subdued.
 (Sharpness)	The higher the value selected, the more the contours are accentuated, and the lower the value selected, the more the contours are softened.

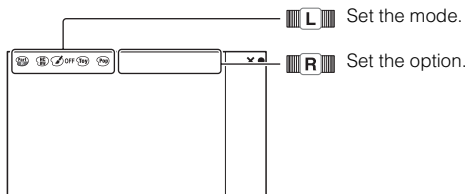
## Picture Effect Settings



Control dial L		
✓	OFF (Off)	Does not use the Picture Effect function.
	(Toy Camera)	Creates the look of a Toy Camera photo with shaded corners and pronounced colors. You can set the color tone with the control dial R.
	(Pop Color)	Creates a vivid look by emphasizing color tones.
	(Posterization)	Creates a high contrast, abstract look by heavily emphasizing primary colors, or in black and white. You can select primary colors or black and white with the control dial R.
	(Retro Photo)	Creates the look of an aged photo with sepia color tones and faded contrast.
	(Soft High-key)	Creates an image with the indicated atmosphere: bright, transparent, ethereal, tender, soft.
	(Partial Color)	Creates an image which retains a specific color, but converts others to black and white. You can select a color with the control dial R.
	(High Contrast Mono.)	Creates a high-contrast image in black and white.
	(Soft Focus)	Creates an image filled with a soft lighting effect. You can set the intensity of the effect with the control dial R.

	 (HDR Painting)	<p>Creates the look of a painting, enhancing the colors and details.</p> <p>The camera releases the shutter 3 times.</p> <p>You can set the intensity of the effect with the control dial R.</p>
	 (Rich-tone Mono.)	<p>Creates an image in black and white with rich gradation and reproduction of details. The camera releases the shutter 3 times.</p>
	 (Miniature)	<p>Creates an image which enhances the subject vividly, with the background defocused considerably. This effect may often be found in pictures of miniature models.</p> <p>You can select the area to be in focus with the control dial R. The focus on other areas is greatly reduced.</p>

## Custom Settings

You can change the mode of the function assigned to [Custom Settings 1, 2, 3]. Assign the function by selecting MENU → [Setup] → [Function Settings] → [Custom Settings 1, 2, 3].

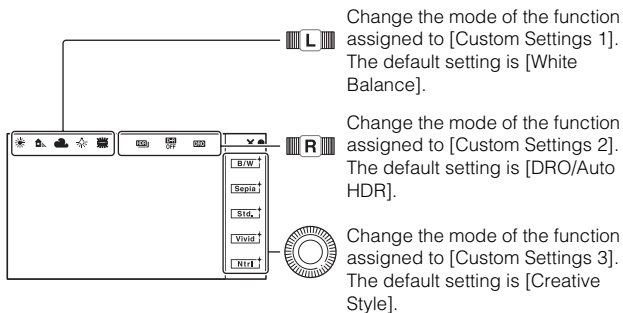

When [Creative Style] or [White Balance] is assigned to [Custom Settings 3], you can make a fine adjustment with soft key B.

## **Custom key assignment**

You can assign the functions you frequently use to any one of 4 keys. This will be handy as you can call up the function by just pressing the key.

## Assigning the functions to the custom keys

You can assign the functions you use frequently to the right key of the control wheel, soft key C, soft key B and AF/MF button.

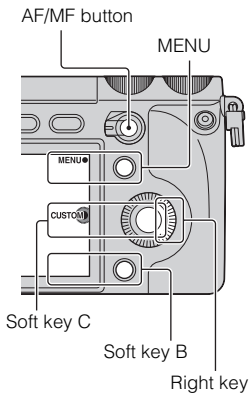

- 
- 1 Select MENU.

---

  - 2 Select [Setup] → [Custom Key Settings].

---

  - 3 Select the function to be assigned.

---

  - 4 Press the key to call up the function assigned to the key.

---

## Functions that can be assigned

The functions that can be assigned to each key are as follows.

✔ indicates the default setting.

### AF/MF button

✔	AF/MF control
	MF Assist
	Focus Settings

### Right Key Setting

	Shoot Mode		White Balance
	AF/MF Select		Metering Mode
	Autofocus Mode		DRO/Auto HDR
	Autofocus Area		Picture Effect
	Precision Dig. Zoom		Creative Style
	Face Detection		Flash Mode
	Smile Shutter		Flash Compensation
	Soft Skin Effect		MF Assist
	Quality		Focus Settings
	ISO	✔	Not set

## Soft key B Setting

	Shoot Mode		White Balance
	AF/MF Select		Metering Mode
	Autofocus Mode		DRO/Auto HDR
	Autofocus Area		Picture Effect
	Precision Dig. Zoom		Creative Style
	Face Detection		Flash Mode
	Smile Shutter		Flash Compensation
	Soft Skin Effect		MF Assist
	Quality	✓	Focus Settings
	ISO		Not set

## Soft key C Setting

✓	Shoot Mode
	Custom

## [Custom] of [Soft key C Setting]

You can set this item when you set [Soft key C Setting] to [Custom].  
The selected items are displayed at the bottom of the screen, when you select CUSTOM with soft key C (the center of the control wheel).  
Select the desired item by pressing the right/left of the control wheel.

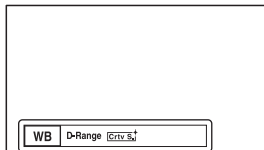

Custom items (Custom 1 to 5)



AF/MF Select
Autofocus Mode
Autofocus Area
Face Detection
Smile Shutter
Soft Skin Effect
Quality
ISO ([Custom 1] default setting)
White Balance ([Custom 2] default setting)
Metering Mode
DRO/Auto HDR ([Custom 3] default setting)
Picture Effect
Creative Style
Flash Mode
Not set ([Custom 4/5] default setting)

## **AF/MF button/AEL button**

You can switch focusing between auto and manual temporarily with the AF/MF button. You can lock the AE with the AEL button.

# Switching the focusing mode with the AF/MF button

The focusing mode switches from auto or direct manual to manual, and from manual to auto.

- 1 Set the AF/MF/AEL switch lever to AF/MF.

The button becomes the AF/MF button.



- 2 Press the AF/MF button.

The focusing mode switches while the button is held down (the default setting).

You can make the focusing mode to remain switched even if you remove your finger from the button by selecting MENU → [Setup] → [AF/MF control].



## Useful functions in the manual focusing mode

You can select the following items by selecting MENU → [Setup].

### MF Assist

Enlarges the image to make manual-focusing easier. The image is enlarged by 5.9 times or 11.7 times. You can also use this with the direct manual focus function.

### Peaking Level/Peaking Color

Enhances the outline of in-focus ranges with a specific color, and allows you to confirm the focus easily.

## Locking the AE with AEL button

---

- 1** Set the AF/MF/AEL switch lever to AEL.

The button becomes the AEL (AE lock) button.



- 2** Focus on the spot for which you want to set the exposure.

- 3** Press the AEL button.

The exposure is locked and \* (AE lock) lights up.

- 4** Holding the AEL button down, focus on your desired subject and shoot.

You can keep the AE locked until you press the AEL button again by selecting MENU → [Setup] → [AEL].

---

## Others

You will find all the setting items available (Menu), certain unique functions, the screen display, specifications, etc. here.

# Menu list

You can select and use various functions from the menu.

When you press MENU, 6 menu items; [Shoot Mode], [Camera], [Image Size], [Brightness/Color], [Playback], and [Setup], appear on the screen.

You can set various functions in each item. Items that cannot be set in the context are displayed in gray.

## Shoot Mode

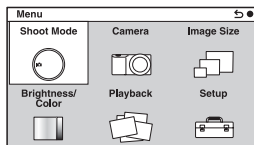

Allows you to select a shooting mode, such as exposure mode, panoramic, Scene Selection.

Intelligent Auto/Manual Exposure/Shutter Priority/Aperture Priority/Program Auto	
Scene Selection	Portrait/Landscape/Macro/Sports Action/Sunset/Night Portrait/Night Scene/Hand-held Twilight
Anti Motion Blur	See page 40.
Sweep Panorama	See page 39.
3D Sweep Panorama	See page 39.

## Camera

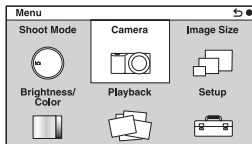

Allows you to set shooting functions, such as continuous shooting, self-timer, remote-control shooting, and flash.

Drive Mode	Single Shooting/Cont. Shooting/Spd Priority Cont./Self-timer/Self-timer(Cont)/ Bracket: Cont./Remote Cdr.
Flash Mode	Flash Off/Autoflash/Fill-flash/Slow Sync./Rear Sync./Wireless
AF/MF Select	Autofocus/DMF/Manual Focus
Autofocus Area	Multi/Center/Flexible Spot
Autofocus Mode	Single-shot AF/Continuous AF
Object Tracking	On/Off
Prec. Dig. Zoom	Max. 10 times
Face Detection	On (Regist. Faces)/On/Off
Face Registration	New Registration/Order Exchanging/Delete/Delete All
Smile Shutter	On/Off
Soft Skin Effect	On/Off
LCD Display (DISP)	Graphic Display/Display All Info./Big Font Size Disp./No Disp. Info./Live View Priority/Level/Histogram/For viewfinder
Finder Display(DISP)	Disp. Basic Info/Level/Histogram
DISP Button(Monitor)	Graphic Display/Display All Info./Big Font Size Disp./No Disp. Info./Live View Priority/Level/Histogram/For viewfinder

# Image Size

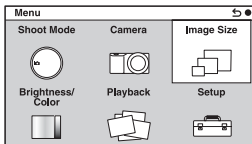

Allows you to set the image size and aspect ratio, etc.

Still	
Image Size	3:2: L: 24M/M: 12M/S: 6M 16:9: L: 20M/M: 10M/S: 5.1M
Aspect Ratio	3:2/16:9
Quality	RAW/RAW & JPEG/Fine/Standard
3D Panorama	
Image Size	16:9/Standard/Wide
Panorama Direction	Right/Left
Panorama	
Image Size	Standard/Wide
Panorama Direction	Right/Left/Up/Down
Movie	
File Format	AVCHD <sup>1)</sup> /MP4
Record Setting	AVCHD: 24M (FX) <sup>2)</sup> /17M (FH) <sup>2)</sup> /28M (PS) <sup>3)</sup> /24M (FX) <sup>4)</sup> /17M (FH) <sup>4)</sup> MP4: 1440×1080 12M/VGA 3M

The interlace or progressive figure varies depending on the countries/regions.

<sup>1)</sup> 60i/60p or 50i/50p

<sup>2)</sup> 60i or 50i

<sup>3)</sup> 60p or 50p

<sup>4)</sup> 24p or 25p



## Brightness/Color

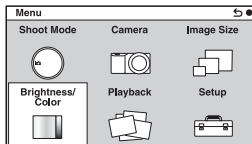

Allows you to make brightness settings such as metering mode, and color settings such as white balance.

Exposure Comp.	-5.0EV to +5.0EV
ISO	ISO AUTO/100 - 16000
White Balance	Auto WB/Daylight/Shade/Cloudy/Incandescent/ Fluor.: Warm White/Fluor.: Cool White/Fluor.: Day White/Fluor.: Daylight/Flash/C.Temp./Filter/Custom/ Custom Setup
Metering Mode	Multi/Center/Spot
Flash Comp.	-3.0EV to +3.0EV
DRO/Auto HDR	Off/D-Range Opt./Auto HDR
Picture Effect	Off/Toy Camera/Pop Color/Posterization/Retro Photo/Soft High-key/Partial Color/High Contrast Mono./Soft Focus/HDR Painting/Rich-tone Mono./ Miniature
Creative Style	Standard/Vivid/Neutral/Clear/Deep/Light/Portrait/ Landscape/Sunset/Night Scene/Autumn leaves/Black & White/Sepia

# Playback

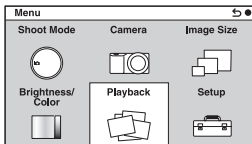

Allows you to set playback functions.

Delete	Multiple Img./All in Folder/All AVCHD view files
Slide Show	Repeat/Interval/Image Type
View Mode	Folder View(Still)/Folder View(MP4)/AVCHD View
Image Index	6 Images/12 Images
Rotate	Counterclockwise
Protect	Multiple Img./Cancel All Images/Cancel All Movies(MP4)/Cancel All AVCHD view files
3D Viewing	3D playback on 3D TV
⊕ Enlarge Image	Enlarging the playback image
Volume Settings	0 to 7
Specify Printing	DPOF Setup/Date Imprint
Display Contents	Display Info./Histogram/No Disp. Info.

# Setup

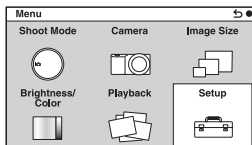

Allows you to make more detailed shooting settings, or change the camera settings.

Shooting Settings	
AEL	Sets how the AEL button works. (Hold/Toggle)
AF/MF control	Sets how the AM/FM button works. (Hold/Toggle)
Dial/Wheel Lock	Sets whether or not to lock the control dials and the control wheel. (All/Control Wheel/Off)
AF Illuminator	Sets the AF illuminator to assist auto-focusing in dim places. (Auto/Off)
Red Eye Reduction	Provides pre-flash before shooting when using the flash, to prevent eyes from being shot in red. (On/Off)
FINDER/LCD Setting	Sets how to switch between the viewfinder and the LCD monitor. (Auto/Viewfinder/LCD Monitor)
Live View Display	Allows you to choose whether or not to show the value of exposure compensation, etc. on the screen display. (Setting Effect ON/Setting Effect OFF)
Auto Review	Sets the display time of the image right after shooting. (10 Sec/5 Sec/2 Sec/Off)
Grid Line	Turns on the grid line that helps you to adjust the composition of images. (Rule of 3rds Grid/Square Grid/Diag. + Square Grid/Off)

Peaking Level	Enhances the outline of in-focus ranges with a specific color. (High/Mid/Low/Off)
Peaking Color	Sets the color used for the peaking function. (White/Red/Yellow)
MF Assist	Displays an enlarged image when focusing manually. (On/Off)
MF Assist Time	Sets the length of time the image will be shown in an enlarged form. (No Limit/5 Sec/2 Sec)
Color Space	Changes the range of color reproduction. (sRGB/AdobeRGB)
SteadyShot	Sets camera shake compensation. (On/Off)
Release w/o Lens	Sets whether or not to release the shutter when there is no lens. (Enable/Disable)
Eye-Start AF	Sets whether or not to use autofocus when you look through the viewfinder, when using the LA-EA2 Mount Adaptor (sold separately). (On/Off)
Front Curtain Shutter	Sets whether or not to use the electronic front curtain shutter function. (On/Off)
Long Exposure NR	Sets the noise reduction processing for long exposure shootings. (On/Off)
High ISO NR	Sets the noise reduction processing for high ISO sensitivity shootings. (High/Normal/Low)
Lens Comp.: Shading	Compensates for the shaded corners of the screen. (Auto/Off)
Lens Comp.: Chro. Aber.	Reduces the color deviation at the corners of the screen. (Auto/Off)
Lens Comp.: Distortion	Compensates for distortion of the screen. (Auto/Off)
Movie Audio Rec	Sets the sound for movie recording. (On/Off)
Wind Noise Reduct.	Reduces wind noise during movie recording. (On/Off)

AF Micro Adj.	Finely adjusts the autofocused position, when using the LA-EA2 Mount Adaptor (sold separately). (AF Adjustment Setting/amount/Clear)
<b>Main Settings</b>	
Menu start	Selects a first-displayed menu from the top menu or the last menu screen. (Top/Previous)
Function Settings	Sets the functions to call up for the Triple-dial-control. (Function Settings 1 to 4/Custom Settings 1 to 3/ Function Settings Start)
Custom Key Settings	Assigns functions to the various keys. (AF/MF button/Right Key Setting/Soft key B Setting/ Soft key C Setting/Custom)
Beep	Selects the sound produced when you operate the camera. (On/Off)
 Language	Selects the language used on the screen.
Date/Time Setup	Sets the date and time.
Area Setting	Selects the area where you are using the camera.
Help Guide Display	Turns the Help Guide on or off. (On/Off)
Power Save	Sets the time to turn the camera to the power save mode. (30 Min/5 Min/1 Min/20 Sec/10 Sec)
LCD Brightness	Sets the brightness of the LCD monitor. (Auto/Manual/Sunny Weather)
Viewfinder Bright.	Sets the brightness of the viewfinder. (Auto/Manual)
Display Color	Selects the color of the LCD monitor. (Black/White)
Wide Image	Selects a method to display wide images. (Full Screen/Normal)
Playback Display	Selects the method used to play back portrait images. (Auto Rotate/Manual Rotate)
HDMI Resolution	Sets resolution when connected to HDMI TV. (Auto/1080p/1080i)
CTRL FOR HDMI	Sets whether or not to operate the camera with a “BRAVIA” Sync-compliant TV’s Remote Control. (On/Off)

USB Connection	Selects the method used for a USB connection. (Auto/Mass Storage/MTP)
Cleaning Mode	Allows you to clean the image sensor.
Version	Displays the version of the camera and the lens.
Demo Mode	Sets whether or not to display the demonstration with movies. (On/Off)
Reset Default	Resets the camera to the factory-settings.
<b>Memory Card Tool</b>	
Format	Formats the memory card.
File Number	Selects the method used for assigning file numbers to images. (Series/Reset)
Folder Name	Selects the folder name format. (Standard Form/Date Form)
Select Shoot. Folder	Selects the recording folder.
New Folder	Creates a new folder.
Recover Image DB	Repairs the image database file when inconsistencies are found.
Display Card Space	Displays the remaining recording time of movies and the recordable number of still images on the memory card.
<b>Eye-Fi Setup*</b>	
Upload Settings	Sets the upload function of the camera when an Eye-Fi card is used. (On/Off)

- \* Appears when an Eye-Fi card (sold separately) is inserted in the camera. Do not use an Eye-Fi card inserted in the camera on an airplane. If there is an Eye-Fi card inserted in the camera, set [Upload Settings] to [Off].  
Eye-Fi cards can be used only in the countries/regions where they were purchased. Use Eye-Fi cards in accordance with the law of the countries/regions where you purchased the card.

# The unique digital shooting functions

Here we will introduce some of the unique functions achieved by full use of Sony imaging technology.

## Sweep Panorama/3D Sweep Panorama

While you pan or tilt the camera, the camera shoots several images and composes them into a panoramic image. Sweep panorama mode allows you to shoot wide, panoramic scenes that cannot fit all at one time on the screen, without any breaks and discontinuity.

In 3D sweep panorama mode, applying the sweep panorama technology, the camera shoots separate images, one to be viewed by the left eye and the other by the right eye, then combines them so that they look like a 3D image.

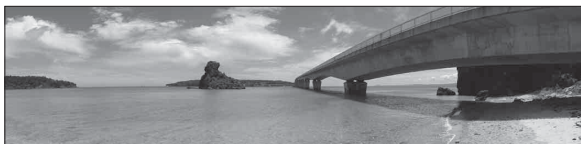

- 1 Select MENU → [Shoot Mode] → [Sweep Panorama] or [3D Sweep Panorama].

- 2 Shoot the subject, following the guidance on the LCD monitor.

The gray area on the left side of the screen is not recorded.



Guidance bar



## Tips for shooting a panoramic image

Pan the camera in an arc with a constant velocity and in the same direction as the indication on the LCD monitor. [Sweep Panorama] is better suited for still subjects, rather than moving ones.

Vertical direction

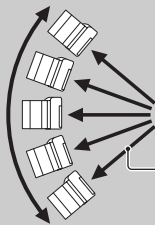

Horizontal direction



Radius as short as possible

## Anti Motion Blur

The camera combines 6 shots at high speed into 1 still image, so camera shake is reduced while also preventing noise. By treating the person (subject) in the foreground and the background separately, both camera shake and subject blur are reduced. Avoiding use of the flash prevents over-exposure.

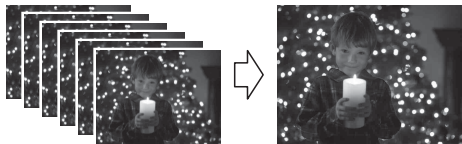

---

1 Select MENU → [Shoot Mode] → [Anti Motion Blur].

---





## The difference between [Anti Motion Blur] and [Hand-held Twilight] functions

Just as with [Anti Motion Blur], the camera combines 6 shots into 1 still image with [Hand-held Twilight] in [Scene Selection].

[Hand-held Twilight] is designed to be used when shooting a dark scene, such as a scene shot at night. When it becomes dark and camera-shake is likely to occur, the camera automatically increases the sensitivity and shoots at a shutter speed that reduces the effect of camera shake.

[Anti Motion Blur] is designed to be used when shooting a subject in low light, such as when shooting indoors. The camera automatically increases the sensitivity and shoots the subject at a high speed shutter setting to reduce the blur caused by movement of the subject.

## Manual movie recording

In the P, A, S, or M mode, you can adjust the exposure even when recording movies. This enables you to produce more creative expression, by reducing the focus on the background, adjusting the brightness, etc.

---

1 Press the MOVIE button.

---

2 Adjust the exposure by using the control dials L/R and the control wheel.

The items that can be adjusted vary depending on the shooting mode (page 13).

---

### Note

- The sound of the lens and the camera in operation will also be recorded.

## **$\alpha$ Handbook**

Refer to “ $\alpha$  Handbook” included on the CD-ROM (supplied) for in-depth instructions on the many functions of the camera.

### **For Windows users**

- 1** Turn on your computer, and insert the CD-ROM (supplied) into the CD-ROM drive.
- 2** Click [Handbook].
- 3** Click [Install].
- 4** Start “ $\alpha$  Handbook” from the shortcut on the desktop.

### **For Macintosh users**

- 1** Turn on your computer, and insert the CD-ROM (supplied) into the CD-ROM drive.
- 2** Select the [Handbook] folder and copy “Handbook.pdf” stored in the [GB] folder to your computer.
- 3** After copying is complete, double-click “Handbook.pdf.”













# Restriction of the functions

## Functions available for each shooting mode

The functions you can use depend on the selected shooting mode.

In the table below, ✓ indicates the function available. – indicates the function not available.

The functions you cannot use are displayed in gray on the screen.

Shoot Mode		Exposure Comp.	Self-timer	Cont. Shooting	Face Detection	Picture Effect
 (Intelligent Auto)		–	✓	✓	✓	–
 (Sweep Panorama)		✓	–	–	–	–
 (3D Sweep Panorama)		✓	–	–	–	–
 (Anti Motion Blur)		✓	–	–	✓	–
SCN (Scene Selection)		–	✓	–	✓	–
		–	✓	✓	✓	–
		–	✓	–	✓	–
		–	✓	–	✓	–
		–	✓	–	✓	–
		–	✓	–	✓	–
		–	–	–	✓	–
		–	✓	–	✓	–
<b>P</b> (Program Auto)		✓	✓	✓	✓	✓
<b>A</b> (Aperture Priority)		✓	✓	✓	✓	✓
<b>S</b> (Shutter Priority)		✓	✓	✓	✓	✓
<b>M</b> (Manual Exposure)		–	✓	✓	✓	✓

### Note

- The functions available may be limited also by conditions other than the shooting mode.

## Flash modes available

The flash modes you can select depend on the shooting mode and functions selected.

In the table below, ✓ indicates the function available. – indicates the function not available.

The flash modes you cannot select are displayed in gray on the screen.

Shoot Mode		Flash Off	Autoflash	Fill-flash	Slow Sync.	Rear Sync.	Wireless
 (Intelligent Auto)		✓	✓	–	–	–	–
 (Sweep Panorama)		✓	–	–	–	–	–
 (3D Sweep Panorama)		✓	–	–	–	–	–
 (Anti Motion Blur)		✓	–	–	–	–	–
SCN (Scene Selection)		✓	✓	✓	–	–	–
		✓	–	✓	–	–	–
		✓	✓	✓	–	–	–
		✓	–	✓	–	–	–
		✓	–	✓	–	–	–
		✓	–	–	–	–	–
		✓	–	–	–	–	–
		–	–	–	✓	–	–
P (Program Auto)		–	–	✓	✓	✓	✓
A (Aperture Priority)		–	–	✓	✓	✓	✓
S (Shutter Priority)		–	–	✓	✓	✓	✓
M (Manual Exposure)		–	–	✓	✓	✓	✓

## Notes

- The flash modes may be limited also by conditions other than the shooting mode.
- Even if you select a workable flash mode, the flash does not fire unless it is raised.
- You cannot use the wireless flash with the built-in flash. Use a wireless lighting ratio control flash (sold separately) or a wireless flash (sold separately).

## Number of recordable images

Once you insert a memory card into the camera and set the power switch to ON, the number of images that can be recorded (should you continue to shoot using the current settings) is displayed on the LCD monitor.



### Note

- When “0” (the number of recordable images) flashes in yellow, the memory card is full. Replace the memory card with another one, or delete images in the current memory card.

## Number of still images and time of movies that can be recorded on a memory card

### Still images

The table shows the approximate number of still images that can be recorded on a memory card formatted with this camera. The values are defined using Sony standard memory cards for testing. The values may vary depending on the shooting conditions.

**Image size: L 24M**

**Aspect ratio: 3:2\***

(Units: images)

Capacity \ Quality	2GB	4GB	8GB	16GB	32GB
Standard	335	680	1350	2750	5500
Fine	205	410	830	1650	3300
RAW & JPEG	54	105	220	440	880
RAW	74	145	300	600	1200

- \* When [Aspect Ratio] is set to [16:9], you can record more images than the numbers shown in the table above (except for [RAW]).

## Movies

The table below shows the approximate recording times available. These are the total times for all movie files. Continuous recording is possible for approximately 29 minutes per recording. The maximum size of an MP4 movie file is about 2 GB.

(h (hour), m (minute))

Capacity Record Setting	2GB	4GB	8GB	16GB	32GB
	60i 24M(FX) 50i 24M(FX)	10 m	20 m	40 m	1 h 30 m
60i 17M(FH) 50i 17M(FH)	10 m	30 m	1 h	2 h	4 h 5 m
60p 28M(PS) 50p 28M(PS)	9 m	15 m	35 m	1 h 15 m	2 h 30 m
24p 24M(FX) 25p 24M(FX)	10 m	20 m	40 m	1 h 30 m	3 h
24p 17M(FH) 25p 17M(FH)	10 m	30 m	1 h	2 h	4 h 5 m
1440×1080 12M	20 m	40 m	1 h 20 m	2 h 45 m	5 h 30 m
VGA 3M	1 h 10 m	2 h 25 m	4 h 55 m	10 h	20 h 5 m

### Note

- The recording time of movies varies because the camera is equipped with VBR (Variable Bit Rate) which automatically adjusts image quality depending on the shooting scene. When you record a fast-moving subject, the image is clearer but the recording time is shorter because a lot of memory needed to record. The recording time also vary depending on the shooting condition or your subject or the setting of image quality/size.

## Number of still images that can be recorded using a battery pack

The approximate number of images that can be recorded is as follows when you use the camera with the battery pack (supplied) at full capacity. Note that the actual numbers may be less depending on the conditions of use.

<b>LCD monitor mode</b>	Approx. 430 images
<b>Viewfinder mode</b>	Approx. 350 images

- The number was estimated with a battery pack at full capacity and under the following conditions:
  - At an ambient temperature of 25°C (77°F).
  - [Quality] is set to [Fine].
  - [Autofocus Mode] is set to [Single-shot AF].
  - Shooting takes place once every 30 seconds.
  - The flash strobes with every second shot.
  - The power is turned off then on again once every 10 shots.
  - Using a battery pack that is charged for an hour after the CHARGE lamp goes out.
  - Using Sony “Memory Stick PRO Duo” media (sold separately).
- The measurement method is based on the CIPA standard.  
(CIPA: Camera & Imaging Products Association)



# List of icons on the screen

Icons are displayed on the screen to indicate the camera status. You can change the screen display using DISP (Display Contents) on the control wheel.

## Shooting standby

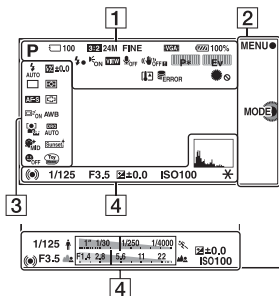

## Movie recording

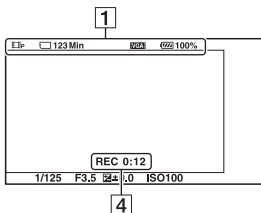



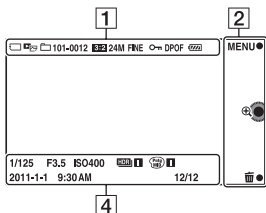

























## Playback





1

Display	Indication
	Shoot Mode
	Scene Selection
	Scene Recognition
	Aspect ratio of still images
	Image size of still images
	Image quality of still images
	Number of recordable still images































Display	Indication
60i/50i <b>FX</b> 60i/50i <b>FH</b> 60p/50p <b>PS</b> 24p/25p <b>FX</b> 24p/25p <b>FH</b> <b>1080</b> <b>VGA</b>	Recording mode of movies
       	Memory card/ Upload
<b>123Min</b>	Recordable time of movies
 <b>100%</b>	Remaining battery
	Flash charge in progress
 ON	AF illuminator
<b>VIEW</b>	Live view
 OFF	Does not record sound during movie recording
 OFF  ON  OFF  ON	SteadyShot/ SteadyShot warning
   	Control dials L/R
	Overheating warning
 FULL  ERROR	Database file full/ Database file error
	Dial/wheel lock
  	View mode

Display	Indication
<b>101-0012</b>	Playback folder – File number
	Protect
<b>DPOF</b>	Print order

2

Display	Indication
<b>MENU</b> ● <b>MODE</b> ●  	Soft keys (MENU/ Shooting mode/ Delete/Enlarge)

3

Display	Indication
 AUTO  SLOW  REAR  WL	Flash Mode/Red Eye Reduction
    10  2  C3  C5  0.3EV  0.7EV 	Drive Mode
<b>DMF</b> <b>AF-S</b> <b>AF-C</b> <b>MF</b>	Focus mode
 ±0.0	Flash compensation
  	Metering Mode
  	Focus area mode
 ON  OFF	Object Tracking
 OFF  ON 	Face Detection
 HI  MID  LO  OFF	Soft Skin Effect

Display	Indication
<b>AWB</b> -1 0  +1  +2 <b>WB</b> <b>7500K</b> <b>A7 G7</b>	White Balance
 <b>DRO/Auto HDR</b>	DRO/Auto HDR
<b>Std.</b> <b>Vivid</b> <b>Ntrl</b> <b>Clear</b> <b>Deep</b> <b>Light</b> <b>Port.</b> <b>Land.</b> <b>Sunset</b> <b>Night</b> <b>Autm</b> <b>B/W</b> <b>Sepia</b>	Creative Style
   OFF	Picture Effect
 	Smile detection sensitivity indicator

4

Display	Indication
	Focus status
<b>1/125</b>	Shutter speed
<b>F3.5</b>	Aperture value
<b>±0.0</b>	Metered manual

Display	Indication
<b>±0.0</b> -5+4+3+2+1+0+1+2+3+4+5+	Exposure compensation
<b>ISO400</b>	ISO sensitivity
	AE lock
1/1000 1/2000 1/4000 1/8000	Shutter speed indicator
f/2.8 f/4 f/5.6 f/8 f/11 f/16 f/22 f/28	Aperture indicator
<b>REC 0:12</b>	Recording time of the movie (m:s)
<b>2011-1-1 9:30AM</b>	Recorded date/time of the image
<b>12/12</b>	Image number/ Number of images in the view mode
	Appears when HDR did not work on the image.
	Appears when Picture Effect did not work on the image.
	Histogram

# Troubleshooting

If you experience trouble with the camera, try the following solutions.

**1** Check the items in “Troubleshooting” in the “ $\alpha$  Handbook” (PDF) included on the CD-ROM (supplied).

**2** Remove the battery pack, wait for about 1 minute, re-insert the battery pack, then turn on the power.

**3** Reset the settings (page 38).

**4** Consult your Sony dealer or local authorized Sony service facility.

# Specifications

## Camera

### [System]

Camera type: Interchangeable lens digital camera

Lens: E-mount lens

### [Image sensor]

Image sensor: 23.5 × 15.6 mm (APS-C format) CMOS image sensor

Total pixel number of image sensor:  
Approx. 24 700 000 pixels

Effective pixel number of camera:  
Approx. 24 300 000 pixels

### [Anti-dust]

System: Charge protection coating on Optical Filter and ultrasonic vibration mechanism

### [Auto focus system]

System: Contrast detection system  
Sensitivity range: EV0 to EV20 (at ISO 100 equivalent, with F2.8 lens)

### [Exposure control]

Metering method: 1 200-segment metering by the image sensor  
Metering range: EV0 to EV20 (at ISO 100 equivalent, with F2.8 lens)

ISO sensitivity (Recommended exposure index):  
Still images: AUTO, ISO 100 to 16000  
Movies: AUTO, ISO 100 to 3200 equivalent

Exposure compensation: ±5.0 EV (1/3 EV step)

### [Shutter]

Type: Electronically-controlled, vertical-traverse, focal-plane type  
Speed range:  
Still images: 1/4 000 second to 30 seconds (1/3 step), bulb

Movies: 1/4 000 second to 1/4 second, up to 1/60 in AUTO mode (1/3 step)

Flash sync speed: 1/160 second

### [Recording media]

“Memory Stick PRO Duo” media, SD card

### [Electronic viewfinder]

Type: Electronic viewfinder (Organic Electro-Luminescence)

Screen size: 1.3 cm (0.5 type)

Total number of dots: 2 359 296 dots

Frame coverage: Approx. 100%

Magnification: 1.09 × with 50 mm lens at infinity, -1 m<sup>-1</sup> (diopter)

Eye point: Approx. 23 mm from the eyepiece, 21 mm from the eyepiece frame at -1 m<sup>-1</sup>

Diopter adjustment: -4.0 m<sup>-1</sup> to +1.0 m<sup>-1</sup> (diopter)

### [LCD monitor]

LCD panel: 7.5 cm (3.0 type) TFT drive

Total number of dots: 921 600 (640 × 3 (RGB) × 480) dots

### [Input/output terminals]

USB: miniB

HDMI: HDMI type C minijack

### [Power]

Used battery pack: Rechargeable battery pack NP-FW50

### [Others]

Exif Print: Compatible

PRINT Image Matching III: Compatible

Dimensions (CIPA compliant):

Approx. 119.9 mm × 66.9 mm × 42.6 mm (4 3/4 inches × 2 3/4 inches × 1 11/16 inches) (W/H/D)

Mass (CIPA compliant):

Approx. 350 g (12.3 oz)  
(including battery and “Memory Stick PRO Duo” media)  
Approx. 291 g (10.3 oz)  
(camera only)

Operating temperature: 0°C to 40°C  
(32°F to 104°F)

File format:

Still image: JPEG (DCF Ver. 2.0,  
Exif Ver. 2.3, MPF Baseline)  
compliant, DPOF compatible  
3D still images: MPO (MPF  
Extended (Disparity Image))  
compliant

Movie (AVCHD format):  
AVCHD format Ver.2.0  
compatible

Video: MPEG-4 AVC/H.264

Audio: Dolby Digital 2ch

Dolby Digital Stereo Creator

- Manufactured under license from  
Dolby Laboratories.

Movie (MP4 format):

Video: MPEG-4 AVC/H.264

Audio: MPEG-4 AAC-LC 2ch

USB communication: Hi-Speed USB  
(USB 2.0)

## [Flash]

Flash guide number: GN 6 (in meters at  
ISO 100)

Recycling time: Approx. 4 seconds

Flash coverage: Covering 18 mm lens  
(focal length that the lens indicates)

Flash compensation:  $\pm 3.0$  EV (1/3 EV  
step)

Flash range (m):

ISO	F2.8	F3.5	F5.6
100	1 - 2.1	1 - 1.7	1 - 1.1
200	1 - 3	1 - 2.4	1 - 1.5
400	1.4 - 4.3	1.1 - 3.4	1 - 2.1
800	2 - 6.1	1.6 - 4.8	1 - 3

Flash range (feet):

ISO	F2.8	F3.5	F5.6
100	3.3 - 6.9	3.3 - 5.6	3.3 - 3.6
200	3.3 - 9.8	3.3 - 7.9	3.3 - 4.9
400	4.6 - 14	3.6 - 11	3.3 - 6.9
800	6.6 - 20	5.2 - 16	3.3 - 9.8

## Battery charger BC-VW1

Input rating: 100 V – 240 V AC,  
50 Hz/60 Hz, 4.2 W

Output rating: 8.4 V DC, 0.28 A

Operating temperature range: 0°C to  
40°C (32° to 104°F)

Storage temperature range: -20°C to  
+60°C (-4°F to +140°F)

Maximum dimensions: Approx. 63 ×  
95 × 32 mm (2 1/2 × 3 3/4 × 1 5/16  
inches) (W/H/D)

Mass: Approx. 85 g (3 oz)

## Rechargeable battery pack NP-FW50

Used battery: Lithium-ion battery

Maximum voltage: DC 8.4 V

Nominal voltage: DC 7.2 V

Maximum charge voltage: DC 8.4 V

Maximum charge current: 1.02 A

Capacity: Typical 7.7 Wh (1 080 mAh)

Minimum 7.3 Wh (1 020 mAh)

Maximum dimensions:

Approx. 31.8 × 18.5 × 45 mm  
(1 5/16 × 3/4 × 1 13/16 inches)  
(W/H/D)

Mass: Approx. 57 g (2.1 oz)

## Lens (NEX-7K only)

E18 – 55 mm zoom lens

Equivalent 35 mm-format focal  
length<sup>1)</sup>: 27 - 82.5 mm

Lens groups-elements: 9-11

Angle of view<sup>1)</sup>: 76° - 29°

Minimum focus<sup>2)</sup>: 0.25 m (0.82 ft)

Maximum magnification: 0.3×

Minimum f-stop: f/22 - f/32

Filter diameter: 49 mm

Dimensions (max. diameter × height):

Approx. 62.0 × 60.0 mm

(2 1/2 × 2 3/8 inches)

Mass: Approx. 194 g (6.8 oz)

Compensation effect<sup>3)</sup>: Approx. 4 steps

- 1) The values for equivalent 35 mm-format focal length and angle of view are based on digital cameras equipped with an APS-C sized image sensor.
- 2) Minimum focus is the shortest distance from the image sensor to the subject.
- 3) Shutter speed (differs with shooting conditions)

Design and specifications are subject to change without notice.

## On focal length

The picture angle of this camera is narrower than that of a 35 mm-format film camera. You can find the approximate equivalent of the focal length of a 35 mm-format film camera, and shoot with the same picture angle, by increasing the focal length of your lens by half.

For example, by using a 50 mm lens, you can get the approximate equivalent of a 75 mm lens of a 35 mm-format film camera.

## On image data compatibility

- This camera conforms with DCF (Design rule for Camera File system) universal standard established by JEITA (Japan Electronics and Information Technology Industries Association).
- Playback of images recorded with your camera on other equipment and playback of images recorded or

edited with other equipment on your camera are not guaranteed.

# Index

## Numerics

3D Sweep Panorama..... 39

## A

AE lock ..... 28, 35  
AEL..... 35  
AF Illuminator ..... 35  
AF Micro Adj. .... 37  
AF/MF control ..... 27, 35  
AF/MF Select..... 31  
Anti Motion Blur ..... 40  
Aperture Priority ..... 13, 30  
Area Setting ..... 37  
Aspect Ratio..... 32  
Auto Review ..... 35  
Autofocus Area ..... 13, 31  
Autofocus Mode ..... 31

## B

Beep ..... 37

## C

Cleaning Mode..... 38  
Color Space..... 36  
Control wheel..... 6, 7, 8  
Creative Style..... 17, 33  
CTRL FOR HDMI..... 37  
Custom key assignment ..... 22  
Custom Key Settings ..... 22  
Custom Settings ..... 20

## D

Date/Time Setup ..... 37  
Delete ..... 7, 34  
Demo Mode ..... 38  
Dial/Wheel Lock..... 35  
DISP Button(Monitor) ..... 31  
Display Card Space..... 38  
Display Color ..... 37  
D-Range Settings ..... 16

Drive Mode ..... 31  
DRO/Auto HDR..... 33

## E

Enlarge Image ..... 7, 34  
Exposure compensation ..... 13, 33  
Eye-Fi Setup..... 38  
Eye-Start AF..... 36

## F

Face Detection..... 31  
Face Registration..... 31  
File Format ..... 32  
File Number ..... 38  
Finder Display(DISP)..... 31  
FINDER/LCD Setting ..... 35  
Flash ..... 6, 44  
Flash Comp. .... 33  
Flash Mode..... 31  
Focus Settings (AF mode)..... 13  
Focus Settings (MF mode) ..... 14  
Folder Name ..... 38  
Format ..... 38  
Front Curtain Shutter..... 36  
Function Settings..... 37

## G

Grid Line ..... 35

## H

Handbook ..... 42  
Hand-held Twilight ..... 41  
HDMI Resolution..... 37  
Help Guide Display ..... 37  
High ISO NR ..... 36

## I

Icons ..... 49  
Image index ..... 7  
Image Size ..... 32



Intelligent Auto .....	30
ISO .....	33

## L

Language .....	37
LCD Brightness .....	37
LCD Display (DISP) .....	31
Lens Comp.: Chro. Aber. ....	36
Lens Comp.: Distortion .....	36
Lens Comp.: Shading .....	36
Live View Display .....	35
Long Exposure NR .....	36

## M

Manual Exposure .....	13, 30
Manual movie recording .....	41
Menu .....	30
Menu start .....	37
Metering Mode .....	33
MF Assist .....	27, 36
MF Assist Time .....	36
Movie .....	6, 41
Movie Audio Rec .....	36

## N

New Folder .....	38
Number of recordable images .....	46

## O

Object Tracking .....	31
-----------------------	----

## P

Panorama .....	39
Panorama Direction .....	32
Peaking Color .....	27, 36
Peaking Level .....	27, 36
Picture Effect .....	19, 33
Playback .....	7
Playback Display .....	37
Playback zoom .....	7
Power .....	5
Power Save .....	37
Prec. Dig. Zoom .....	31

Program Auto .....	13, 30
Protect .....	34

## Q

Quality .....	32
---------------	----

## R

Record Setting .....	32
Recording .....	5
Recover Image DB .....	38
Red Eye Reduction .....	35
Release w/o Lens .....	36
Reset Default .....	38
Rotate .....	34

## S

Scene Selection .....	30
Screen display .....	6, 7, 49
Select Shoot. Folder .....	38
Setup .....	35
Shutter Priority .....	13, 30
Slide Show .....	34
Smile Shutter .....	31
Soft key .....	8
Soft Skin Effect .....	31
Specifications .....	53
Specify Printing .....	34
SteadyShot .....	36
Sweep Panorama .....	39

## T

Triple-dial-control .....	10
---------------------------	----

## U

Upload Settings .....	38
USB Connection .....	38

## V

Version .....	38
View Mode .....	34
Viewfinder Bright .....	37
Volume Settings .....	34

## **W**

White Balance.....	14, 33
Wide Image.....	37
Wind Noise Reduct.....	36

## **Z**

Zoom.....	5
-----------	---











Additional information on this product and answers to frequently asked questions can be found at our Customer Support Website.

<http://www.sony.net/>

Printed using VOC (Volatile Organic Compound)-free vegetable oil based ink.

©2011 Sony Corporation Printed in Thailand  
4-408-688-12(1)



4408688120