

SONY®



Table of
contents

Operation
Search

Settings
Search

Index

Handbook

Digital HD Video Camera Recorder

HDR-AS30/AS30V

How to use this handbook

Click on a button on the right to jump to the corresponding page.
This is convenient when searching for a function you want to view.



← Search for information by function.

← Search for information by operation.

← Search for information in a listing of Settings items.

← Search for information by keyword.

Table of contents

Operation Search

Settings Search

Index

Marks and notations used in this handbook

Recording Mode

Setting display: [SETUP] → [VIDEO]

You can set the image resolution and frame rate for shooting movies.
To make the setting, select [SETUP] first.

- 1 Press the NEXT button to display [SETUP], then press the ENTER button.
- 2 While [VIDEO] (Recording Mode) is displayed, press the ENTER button.
- 3 Press the NEXT button to select the Recording Mode, then press the ENTER button.

Display	Recorded image	Resolution	Imaging frame rate	Playback frame rate
	Highest resolution/smooth image recorded at 2x frame rate	1920x1080	60p/50p	60p/50p
	High resolution	1280x720	30p/25p	30p/25p
	Slow motion image recorded at 2x by time difference from Greenwich Mean Time (GMT).	1280x720	60p	

Notes

- Summer time setting is not available on this camera.
- When you set the GPS log to [ON], the camera adjusts date, time and region automatically during shooting mode (HDR-AS30V only).

Setting the region

You can set the clock to the local time of a country you visit by selecting the region. Regions are defined by time difference from Greenwich Mean Time (GMT). Refer also to "World time difference" (page 66).

← The default setting is indicated by ✓.

← Indicates cautions and limitations relevant to the correct operation of the camera.

💡 Indicates information that is useful to know.

Notes on using the camera

About the displayed language

The display panel displays only English. Other languages are not available.

Notes on recording/playback and connection

- Before you start recording, make a trial recording to make sure that the camera is working correctly.
- To play back images, connect the camera to another device with a micro HDMI cable (sold separately).
- The camera is neither dust-proof, nor splash-proof, nor water-proof. Read “Precautions” (page 67) before operating the camera.
- Avoid exposing the camera to water. If water enters inside the camera, a malfunction may occur. In some cases, the camera cannot be repaired.
- Do not aim the camera at the sun or other bright light. It may cause malfunctions.
- Do not use the camera near a location that generates strong radio waves or emits radiation. Otherwise, the camera may not properly record or play back images.
- Using the camera in sandy or dusty locations may cause malfunctions.
- If moisture condensation occurs, remove it before using the camera (page 67).
- Do not shake or strike the camera. It may cause a malfunction and you may not be able to record images. Furthermore, a memory card may become unusable or image data may be damaged.
- When connecting the camera to another device with a cable, be sure to insert the connector plug in the correct way. Pushing the plug forcibly into the terminal will damage the terminal and may result in a malfunction of the camera.
- Playback of movies other than those shot, edited or composed on this camera is not guaranteed.
- When you switch between NTSC/PAL, the setting values that can be selected in the Recording Mode change accordingly. Settings values for both [NTSC] and [PAL] are shown in this manual.

On camera's temperature

The camera may get warm due to continuous use, but it is not a malfunction.

On the overheat protection

Depending on the camera and battery temperature, you may be unable to record movies or the power may turn off automatically to protect the camera. A message will be displayed on the display panel before the power turns off or you can no longer record movies.

Notes on the battery pack

- Charge the battery pack before using for the first time.
- You can charge the battery pack even if it is not completely discharged. In addition, even if the battery pack is not fully charged, you can use the partially charged capacity of the battery pack as is.
- For details on the battery packs, see page 65.

Notes on the display panel and lens

- Exposing the display panel or the lens to direct sunlight for long periods may cause malfunctions. Be careful when placing the camera near a window or outdoors.
- Do not press against the display panel. It may cause a malfunction.

On image data compatibility

- This camera supports "MP4 format" as movie file format. However, it is not guaranteed that all MP4 compliant devices can play back images recorded with this camera.
- The camera conforms with DCF (Design rule for Camera File system) universal standard established by JEITA (Japan Electronics and Information Technology Industries Association).

Warning on copyright

Television programs, films, videotapes, and other materials may be copyrighted. Unauthorized recording of such materials may be contrary to the provisions of the copyright laws.

No compensation for damaged content or recording failure

Sony cannot compensate for failure to record or loss or damage of recorded content due to a malfunction of the camera or memory card, etc.

The illustrations and images used in this handbook

- The images used as examples in this handbook are reproduced images, and are not actual images shot using the camera.
- In this manual, “Memory Stick Micro” media and microSD memory card are referred to as “memory card.”
- Design and specifications are subject to change without notice.

Notes on playing back on other devices

- The camera is compatible with MPEG-4 AVC/H.264 Main Profile for HD (high definition) image quality recording. Therefore, you cannot play back images recorded with HD (high definition) image quality on the camera with the devices which are not compatible with the MPEG-4 AVC/H.264.
- Movies recorded using this camera may not play back normally on devices other than this camera. Also, movies recorded on other devices may not play back properly on this camera.

On wireless network function

- The wireless network function built into this camera has been confirmed to conform with Wi-Fi specifications set forth by the Wi-Fi Alliance (WFA).
- Depending on the region, access to a wireless LAN may not be available, may require a separate service charge, or communications may be blocked or suffer from intermittent outages. For details, check your wireless LAN administrator and/or service provider.
- Sony makes no guarantees whatsoever in the provision of a network service. Sony bears absolutely no responsibility for damages that may arise from the use of a network service even in the case of claims made by a third-party.
- We assume no responsibility whatsoever for any damage caused by unauthorized access to, or unauthorized use of, destinations loaded on the camera, resulting from loss or theft.

About the security on using Wireless LAN products

It is important to set security when using the wireless network function. Sony makes no guarantees and is not responsible for any damage resulting from having inadequate security or using the wireless network function.

Carl Zeiss lens

The camera is equipped with a Carl Zeiss lens which is capable of reproducing sharp images with excellent contrast. The lens for the camera has been produced under a quality assurance system certified by Carl Zeiss in accordance with the quality standards of Carl Zeiss in Germany.

On GPS-compatible devices (HDR-AS30V only)

- Use GPS in accordance with regulations of countries and regions where you use it.
- If you do not record the location information, set the GPS log to [OFF] (page 25).
- If you take images with the GPS log set to [ON], and upload those images to the internet, the shooting location may be available to third parties. To prevent this, set the GPS log to [OFF] before shooting (page 25).

How to enjoy the camera

Enjoy more using the accessories

Handlebar Mount & Waterproof Case



Wrist Mount Strap & Waterproof Case



Handheld Grip with LCD Screen



Table of
contents

Operation
Search

Settings
Search

Index

Share your life

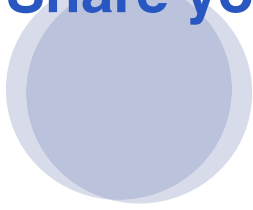

Upload captured moments

You can directly upload images and share them by using the wireless network function of this camera (page 45).

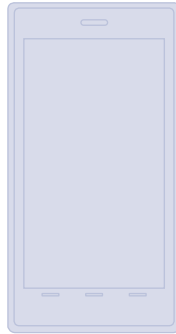

Record GPS information (HDR-AS30V only)

You can view location information and movement speed while viewing movies using “PlayMemories Home” (page 25).

Connect to TV

Connect the camera to a TV with a micro HDMI cable (sold separately), and enjoy images on the big screen (page 43).



Table of contents

Notes on using the camera

How to use this handbook	2
Notes on using the camera	3
How to enjoy the camera	5
Operation Search	10
Settings Search	11
Identifying parts	13

Getting started

Checking the bundled items	14
Inserting the battery pack	15
Inserting a memory card	18
Recording Mode	20
SteadyShot	21
Field Angle	22
Scene	23
Interval Photo Recording	24
GPS Log (HDR-AS30V only)	25
Airplane Mode	27
Auto Power Off	28
Beep	29
Date & Time Setting	30
USB Power Supply	31
Switching NTSC/PAL	32
Resetting the Settings	33
Format	34
Using accessories	35

Shooting

Shooting	41
----------------	----

Viewing

Viewing images on a TV	43
------------------------------	----

Wireless Network (Wi-Fi)

Preparation for setting Wi-Fi	45
Setting Wi-Fi	46
Smart Remote Control	49
Copy	51

Computer

Useful functions when connecting the camera to your computer	52
Preparing a computer	53
Starting the “PlayMemories Home” software	56

Troubleshooting

Troubleshooting	57
Warning indicators and messages	61

Others

Recordable time	63
Battery pack	65
Using the camera abroad	66
Precautions	67
Specifications	69

Index

Index 72

Table of contents

Operation Search

Settings Search

Index

Operation Search

Table of
contents

Operation
Search

Settings
Search

Index

Shooting movies and photos	Shooting	41
Changing the movie file size	Recording Mode	20
Deleting images	Format	34
Changing the date, time and region	Date & Time Setting.....	30
Initializing settings	Resetting the Settings.....	33
Viewing on TVs	Viewing images on a TV.....	43
Operating using a smartphone or tablet	Smart Remote Control	49
Uploading images to a network service	Setting Wi-Fi	46
Recording the location information	GPS Log (HDR-AS30V only)	25

Settings Search

Setting items

Click each item to jump to the corresponding page.

Items	Display	Default setting
Recording Mode	VIDEO	HQ (1920×1080/30p)
SteadyShot	STEDY	ON
Field Angle	ANGLE	120°
Scene	SCENE	NORML
Interval Photo Recording	LAPSE	5sec
Smart Remote Control	Wi-Fi	ON
Copy*	SHARE	—
GPS Log (HDR-AS30V only)	GPS	ON
Airplane Mode	PLANE	OFF
Auto Power Off	A.OFF	60sec
Beep	BEEP	ON
Date & Time Setting	DATE	2013/1/1 00:00 GMT+0
USB Power Supply	USBPw	ON
Switching NTSC/PAL	V.SYS	NTSC
Resetting the Settings	RESET	—
Format	FORMT	—

* You can change the mode by operating your smartphone when the camera is set to the smart remote control function.

Notes

- The display panel displays only English. Other languages are not available.

How to set items

You can set items using the following 3 buttons on the camera.

NEXT*: Goes to the next menu

PREV*: Goes to the previous menu

ENTER: Executes the menu

* Both NEXT and PREV buttons are used to change the menu.

In this manual, we usually use the NEXT button for description. When using only the PREV button, we describe it as the PREV button.

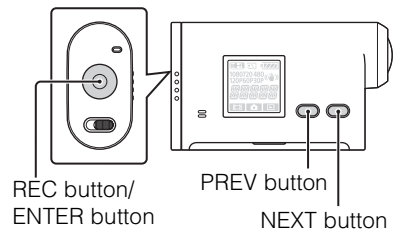

1 Press the NEXT or PREV button to turn on the power.

To power off, select [PwOFF] and press the ENTER button.

2 Press the NEXT button to display [SETUP], then press the ENTER button.

3 Press the NEXT button to display the setting item, then press the ENTER button.

To return to the [SETUP] menu, select [BACK] and press the ENTER button.

Table of
contents

Operation
Search

Settings
Search

Index

Identifying parts

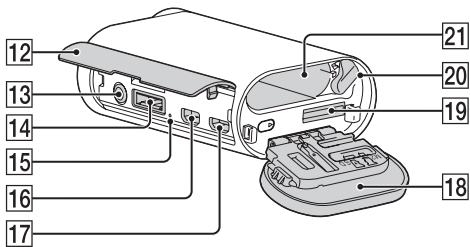
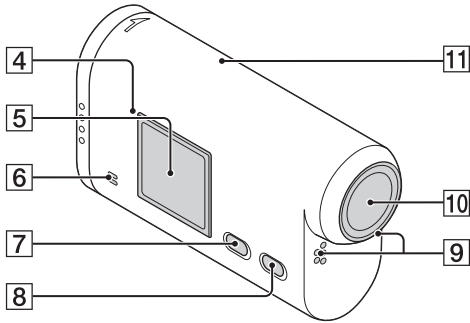
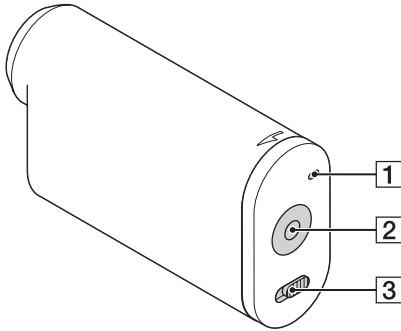

- 1** REC/access lamp
- 2** REC (Movie/Photo) button
ENTER (Menu execute) button
- 3** ◀ REC HOLD switch*¹
- 4**  (N Mark)*²
- 5** Display panel
- 6** Speaker
- 7** PREV button
- 8** NEXT button
- 9** Microphones
- 10** Lens
- 11** GPS sensor (HDR-AS30V only)

- 12** Connector cover
- 13**  (Mic) jack*³
- 14** Expansion connector*⁴
- 15** CHG (Charge) lamp
- 16** HDMI OUT jack
- 17** Multi/Micro USB Terminal*⁵
- 18** Battery pack/memory card cover
- 19** Memory card insertion slot
- 20** Battery ejection lever
- 21** Battery insertion slot

*¹ Used to prevent accidental operation. Slide in the direction of ◀ to lock the REC button. Slide in the opposite direction to release.

*² Touch the mark when you connect the camera to a smartphone equipped with the NFC function.

NFC (Near Field Communication) is an international standard of the short-range wireless communication technology.

*³ When an external microphone (sold separately) is connected, audio cannot be recorded through the built-in microphone.

*⁴ Used to connect accessories.

*⁵ Supports Micro USB compatible devices.

Checking the bundled items

Make sure that you have following bundled items.

The number in parentheses indicates the quantity of that item bundled.

- Camera (1)
- Micro USB cable (1)



- Rechargeable battery pack (NP-BX1) (1)



- Waterproof Case (SPK-AS2) (1)

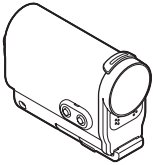

- Adhesive Mount (VCT-AM1) Attachment Buckle (1)

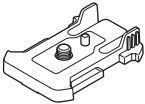

Flat Adhesive Mount (1)

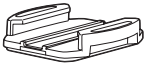

Curved Adhesive Mount (1)

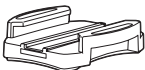

- Handbook (this manual)
Included in the internal memory of this camera.
- Set of printed documentation

Inserting the battery pack

- 1 Slide the battery pack/memory card cover in the direction of the arrow, then open the cover.

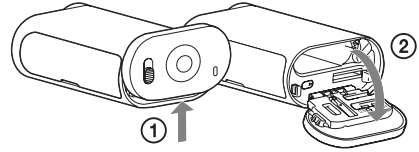

- 2 Insert the battery pack.

Make sure the direction of the battery pack is correct, then insert it pushing against the battery ejection lever, until the lever locks.

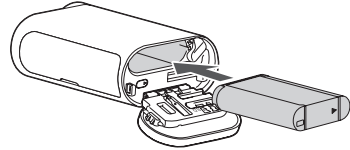

- 3 Close the cover.

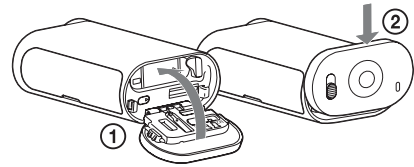

To set Auto Power Off function

Select [A.OFF] from the [SETUP] screen, then set the Auto Power Off function. The default setting is [60sec]. Change the setting as necessary. For details, see “Auto Power Off” (page 28).

Charging the battery pack

- 1 Turn off the power of the camera.
Charging is not possible when the camera is turned on.
- 2 Connect the camera to the computer that is turned on with the micro USB cable (supplied).
The CHG (Charge) lamp lights up.

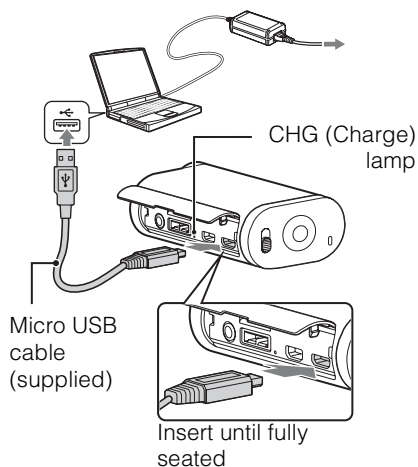

- 3 When charging is finished, delete the USB connection between the camera and the computer (page 55).
Charging is complete when the CHG (Charge) lamp turns off (full charge) (page 65).

Notes

- You can use only type X battery with this camera.
- Turn off the camera while charging the battery.
- Do not apply force to the camera, when you connect the camera to a computer. This may cause damage to the camera or the computer.
- When you connect the camera to a notebook computer that is not connected to an AC power source, the battery of the notebook computer may be depleted rapidly. Do not leave the camera connected to the computer for a long time.
- Charging the battery pack or the connection with customized or hand-built computers is not guaranteed. Depending on the type of USB device used, charging may not function properly.
- Operation with all computers is not assured.
- If you do not intend to use the camera for an extended period, charge the camera once every 6 to 12 months to maintain battery performance.

💡 How long does it take to charge the camera?

Charging time

Battery pack	Via a computer	Via AC-UD20* (sold separately)
NP-BX1 (supplied)	Approx. 245 min.	Approx. 175 min.

- Time required to charge a fully depleted battery pack at a temperature of 25°C (77°F). Charging may take longer under certain circumstances or conditions.
- * Rapid charging is possible by using the USB charger AC-UD20 (sold separately). To connect to the charger, use the micro USB cable (supplied).



Checking the remaining battery charge

A remaining charge indicator appears on the upper right of the display panel.

High      Low



- The displayed remaining charge indicator may not be correct under certain circumstances.
- It takes about one minute until the correct remaining charge indicator appears.

Inserting a memory card

1 Slide the Battery pack/memory card cover in the direction of the arrow, then open the cover.

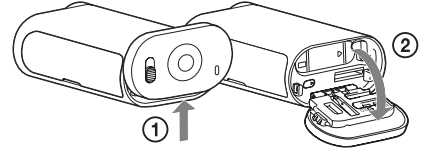

2 Insert the memory card until it clicks.

microSD card: Insert in the direction of **A**.
 “Memory Stick Micro (M2)” media: Insert in the direction of **B**.

- When [WAIT] appears on the display panel, wait until the message disappears.
- Insert a memory card squarely in the correct orientation; otherwise, the camera will not recognize it.

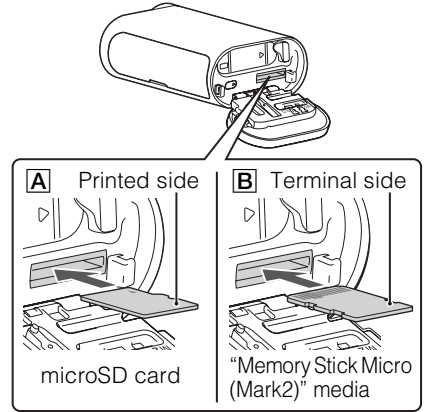

3 Close the cover.

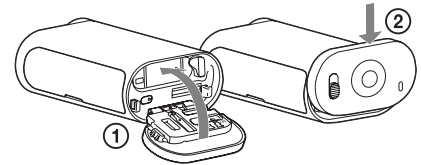

💡 To eject the memory card

Open the cover, then lightly push the memory card once.

💡 What types of memory cards you can use with this camera?

Types of memory cards	SD Speed Class	Phrase in this book
“Memory Stick Micro (Mark2)” media	—	“Memory Stick Micro” media
microSD memory card	Class 4 or faster	microSD card
microSDHC memory card		
microSDXC memory card		

- Operation with all memory cards is not assured.

Notes

- In order to stabilize memory card operation, it is recommended that you format the memory card when you use it with the camera for the first time (page 34).
All data recorded on the memory card will be erased by formatting, and cannot be recovered.
- Save important data on the memory card on other media such as a computer, before formatting the memory card.
- If you insert a memory card into the slot in the wrong direction, the memory card, the memory card slot, or image data may be damaged.
- Do not insert anything other than the compliant size of memory card into the memory card slot. Otherwise, a malfunction may result.
- When inserting or ejecting the memory card, be careful to prevent the memory card from popping out and dropping.
- Guaranteed operating temperature of the camera is between 0°C to 40°C (32°F to 104°F). However, depending on the types of memory cards, guaranteed operating temperature varies.
For details, refer to the operating instructions supplied with the memory card.
- Images recorded in a microSDXC memory card cannot be transferred or played back on a computer or AV device that is not exFAT*-compatible (via USB connection). Before connecting, make sure that the device is exFAT-compatible. If the camera is connected to a device that is not exFAT-compatible, a prompt to format the memory card may appear. In this case, do not format the memory card, otherwise all its data will be lost.
* exFAT is the file system used by microSDXC memory cards.

Recording Mode

Setting display



You can set the image resolution and frame rate for shooting movies.
To make the setting, select [SETUP] first.

- 1 Press the NEXT button to display [SETUP], then press the ENTER button.
- 2 While [VIDEO] (Recording Mode) is displayed, press the ENTER button.
- 3 Press the NEXT button to select the Recording Mode, then press the ENTER button.

	Display	Recorded image	Resolution	Imaging frame rate	Playback frame rate
		Highest resolution/smooth image recorded at 2x frame rate	1920x1080	60p/50p	60p/50p
✓		Highest resolution	1920x1080	30p/25p	30p/25p
		High resolution	1280x720	30p/25p	
		Slow motion image recorded at 2x frame rate	1280x720	60p	30p
		Super slow motion image recorded at 4x frame rate	1280x720	120p	
		Standard resolution	640x480	30p/25p	30p/25p
		Returns to the [VIDEO] menu.			

Notes

- Continuous movie shooting time is approximately 13 hours.
In [SLOW] mode, it is approximately 6.5 hours.
In [SSLOW] mode, it is approximately 3 hours.
- If you select [SSLOW], SteadyShot will not be effective even if SteadyShot is set to [ON].
- Audio is not recorded during shooting in the following situation:
 - [SSLOW] (720 120p), [SLOW] (720 60p) is set.
- When the Recording Mode is set to [VGA], the angle of view becomes narrower compared to other Recording Modes.
- Frame rate depends on the NTSC/PAL setting (page 32).
- If the NTSC/PAL setting is switched to [PAL], the frame rate will not be displayed.

Table of contents

Operation Search

Settings Search

Index

SteadyShot



You can activate the camera-shake reduction when shooting.
To make the setting, select [SETUP] first.

- 1 Press the NEXT button to display [SETUP], then press the ENTER button.
- 2 Press the NEXT button to display [STEDY] (SteadyShot), then press the ENTER button.
- 3 Press the NEXT button to select the setting, then press the ENTER button.

✓		Uses SteadyShot.
		Does not use SteadyShot.
		Returns to the [STEDY] menu.

Notes

- When SteadyShot is set to [ON], the field angle will be set to [120°].
- When the field angle is set to [170°], SteadyShot will be set to [OFF].
- When the Recording Mode is set to [SSLOW], SteadyShot will not be effective.
- SteadyShot is not available when the camera is set to the photo mode.

Table of contents

Operation Search

Settings Search

Index

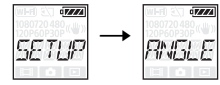

Field Angle

Setting display



You can change the field angle for recording.
To make the setting, select [SETUP] first.

- 1 Press the NEXT button to display [SETUP], then press the ENTER button.
- 2 Press the NEXT button to display [ANGLE] (Angle), then press the ENTER button.
- 3 Press the NEXT button to select the setting, then press the ENTER button.

		Records with a field angle of 170°.
✓		Records with a field angle of 120°.
		Returns to the [ANGLE] menu.

Notes

- When SteadyShot is set to [ON], the field angle will be set to [120°].
- When the field angle is set to [170°], SteadyShot will be set to [OFF].
- When the Recording Mode is set to [VGA], the angle of view becomes narrower compared to other Recording Modes.

Table of contents

Operation Search

Settings Search



Index

Scene



You can select suitable image quality according to the shooting scene.
To make the setting, select [SETUP] first.

- 1 Press the NEXT button to display [SETUP], then press the ENTER button.
- 2 Press the NEXT button to display [SCENE] (Scene), then press the ENTER button.
- 3 Press the NEXT button to select the setting, then press the ENTER button.



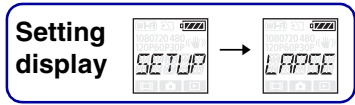

✓		Shoots images in the standard quality.
		Shoots images in an image quality suitable for underwater shooting.
		Returns to the [SCENE] menu.

Interval Photo Recording



You can set the interval period of the interval photo recording.
To make the setting, select [SETUP] first.

- 1 Press the NEXT button to display [SETUP], then press the ENTER button.
- 2 Press the NEXT button to display [LAPSE] (Interval), then press the ENTER button.
- 3 Press the NEXT button to select the setting, then press the ENTER button.

✓		Continues to record photos at about 5-second intervals.
		Continues to record photos at about 10-second intervals.
		Continues to record photos at about 30-second intervals.
		Continues to record photos at about 60-second intervals.
		Returns to the [LAPSE] menu.

Notes

- The first photo is recorded immediately after recording is started, without waiting for the completion of the set interval. From the second photo, photos will be recorded at the set intervals.
- If it is not possible to record photos at the set intervals, the recording will be delayed.
- The maximum number of recordable files is 40,000 in total, including movie (MP4) files.

GPS Log (HDR-AS30V only)

Setting display

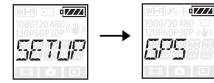

You can record the location information and the movement speed while recording movies using the camera's GPS function.

The "PlayMemories Home" software allows you to import movies recorded with GPS log to a computer and view them with a map showing location information (page 52).

- 1 Press the NEXT button to display [SETUP], then press the ENTER button.
- 2 Press the NEXT button to display [GPS] (GPS), then press the ENTER button.
- 3 Press the NEXT button to select the setting, then press the ENTER button.

✓		Records movies with the GPS log and still images with location information.
		Does not use GPS log.
		Returns to the [GPS] menu.

Notes

- GPS log is available only when recording movies.
- If you do not record the location information, set the GPS log to [OFF].
- During take off and landing of an airplane, set the airplane mode to [ON] (page 27).
- Use GPS in accordance with the regulations of the place or situation.
- It may take from several tens of seconds to several minutes to acquire the location information when you use the GPS for the first time or use it again after long intervals. Triangulating time can be shortened by taking in GPS assist data (page 26).
- Do not cover the GPS sensor with your finger when searching for GPS satellites or when triangulating. This decreases the sensitivity of the GPS sensor and triangulation may fail (page 13).
- Sony does not collect location information and routing information.
- To display location information and routing information as a map on a computer, Sony provides data of location information and routing information to Google Inc.
- Although the camera does not have the function to delete log files, you can delete them by formatting the media.
- When shooting still images while GPS log is set to [ON], only the location information will be recorded.
- The maximum number of log files that can be recorded is 256/day. When the maximum number of recorded log files is reached, you can continue to shoot images, however log files will not be recorded.

Table of contents



Operation Search

Settings Search

Index

Checking triangulating status

The indicator changes according to the strength of GPS signal reception when GPS is activated.

GPS Indicators	Triangulating status	GPS reception status
No indicator	OFF	The GPS log is set to [OFF] or an error occurred.
	Searching/Difficult	Searching for GPS satellites. It may take several minutes to start triangulating.
	Triangulating	Your camera is receiving a GPS signal, and can acquire location information.

About GPS assist data

The time for the GPS acquiring location information can be shortened by taking in GPS assist data. If connection via Internet is made using the software, “PlayMemories Home,” the GPS assist data can be updated automatically.

- If the Date & Time Setting is not set, or set time is shifted greatly, the time for the GPS acquiring location information cannot be shortened.
- If the term of validity of GPS assist data has run out, the time until you can record location information cannot be shortened.

Using the GPS support tool

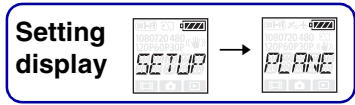

You can also update the GPS assist data by inserting a memory card into the computer. Display the main screen of the “PlayMemories Home” and select the connected model name → [GPS Support Tool] → the desired memory card drive to be installed from your computer, and then update the GPS assist data. If you insert this memory card, the GPS assist data will be reflected on the camera.

Airplane Mode



When you are in an airplane or another restricted place, you can set the camera to disable all functions related to the wireless applications such as Wi-Fi, etc. If you set the airplane mode to [ON], an airplane mark will be displayed on the display panel.

- 1 Press the NEXT button to display [SETUP], then press the ENTER button.
- 2 Press the NEXT button to display [PLANE] (Airplane Mode), then press the ENTER button.
- 3 Press the NEXT button to select the setting, then press the ENTER button.

		Select this when you are on board an airplane.
✓		Select this for normal use.
		Returns to the [PLANE] menu.

Auto Power Off



You can change the setting of the Auto Power Off function.
To make the setting, select [SETUP] first.

- 1 Press the NEXT button to display [SETUP], then press the ENTER button.
- 2 Press the NEXT button to display [A.OFF] (Auto Power Off), then press the ENTER button.
- 3 Press the NEXT button to select the setting, then press the ENTER button.

		Turns the power off after about 10 seconds.
✓		Turns the power off after about 60 seconds.
		Does not turn off automatically.
		Returns to the [A.OFF] menu.

Notes



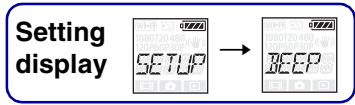

- This function is not available in the following situations.
 - Recording data to media
 - Shooting movies, or shooting in interval photo recording mode
 - During movie playback, or a slideshow
 - Wi-Fi connection is in process, smart remote control is being connected, or an image is being uploaded to a smartphone
 - HDMI connection is being made
 - Supplying power from a connected USB device
 - Connecting a mass storage device
- In the following cases, even if you have selected [10sec] or [60sec] in the Auto Power Off function, the time that elapses before the power turns off will be extended.
 - while adjusting [SETUP] settings
 - while playing back photos
 - when [Wi-Fi] is set to [ON] and the Wi-Fi icon is displayed.

Beep



You can set the audible notification of operations to ON/OFF.
To make the setting, select [SETUP] first.

- 1 Press the NEXT button to display [SETUP], then press the ENTER button.
- 2 Press the NEXT button to display [BEEP] (Beep), then press the ENTER button.
- 3 Press the NEXT button to select the setting, then press the ENTER button.

✓		All operation sounds are enabled.
		Operation sounds are emitted for the following operations only. <ul style="list-style-type: none"> • Power turned on • Recording started • Recording stopped • Shutter pressed • A disabled operation was selected or an error occurred
		All operation sounds are disabled.
		Returns to the [BEEP] menu.

Date & Time Setting

Setting display

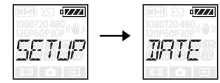

You can set the year/month/day and region.
To make the setting, select [SETUP] first.

- 1 Press the NEXT button to display [SETUP], then press the ENTER button.
- 2 Press the NEXT button to display [DATE] (Date Time), then press the ENTER button.
- 3 Press the NEXT button to select the desired date, time and region, then press the ENTER button to confirm.
Select 00:00 for midnight, 12:00 for noon.

Display	Default setting	
	2013	Sets the year.
	01	Sets the month.
	01	Sets the day.
	00	Sets the hour.
	00	Sets the minutes.
	GMT+0	Sets the region in which you use the camera. (Regions are defined by time difference from Greenwich Mean Time (GMT)).

Notes

- Summer time setting is not available on this camera.
- When you set the GPS log to [ON], the camera adjusts date, time and region automatically during shooting mode (HDR-AS30V only).

Setting the region

You can set the clock to the local time of a country you visit by selecting the region. Regions are defined by time difference from Greenwich Mean Time (GMT). Refer also to “World time difference” (page 66).

Table of contents

Operation Search

Settings Search

Index

USB Power Supply

Setting display



When connecting the camera to a computer or USB device with the micro USB cable (supplied), the camera can be set so the connected device supplies power to it. To make the setting, select [SETUP] first.

- 1 Press the NEXT button to display [SETUP], then press the ENTER button.
- 2 Press the NEXT button to display [USBPw] (USB Power), then press the ENTER button.
- 3 Press the NEXT button to select the setting, then press the ENTER button.

✓		Supplies power from a connected device, through the micro USB cable.
		Does not supply power from a connected device, through the micro USB cable.
		Returns to the [USBPw] menu.

Notes

- If you change the setting while the micro USB cable is connected, disconnect the cable, then reconnect.
- Power may not be supplied properly from a USB device with a power supply capacity of less than 1.5 A.



How to supply power from a wall outlet (wall socket)

Rapid charging is possible by using the USB charger AC-UD20 (sold separately). To connect to the charger, use the micro USB cable (supplied).

Table of contents

Operation Search

Settings Search

Index

Switching NTSC/PAL

Setting display





You can select NTSC/PAL, depending on the TV system of the country or region where you use this camera.

To make the setting, select [SETUP] first.

- 1 Press the NEXT button to display [SETUP], then press the ENTER button.
- 2 Press the NEXT button to display [V.SYS] (Video System), then press the ENTER button.
- 3 Press the NEXT button to select the setting, then press the ENTER button.
- 4 Press the NEXT button, then press the ENTER button while [OK] is displayed on the display panel.

To cancel the NTSC/PAL setting, press the NEXT button while [OK] is displayed, select [CANCL], then press the ENTER button.

✓		When the TV system is NTSC.
		When the TV system is PAL.
		Returns to the [V.SYS] menu.

Notes

- When you select [PAL], the camera behaves as follows.
 - [SLOW] and [SSLOW] are not available.
 - When the camera is set to the movie mode, the frame rate is not displayed.
 - On the Recording Mode setting screen, the frame rate is not displayed.
- When you change the NTSC/PAL setting, the camera will restart automatically.
- Recording media formatted or recorded in NTSC cannot be recorded or played in PAL, and vice versa. If [FORMT] appears on the display panel after switching the NTSC/PAL setting, go to the confirmation screen and select [OK], then format the current recording media, or use another recording media (page 34).

Table of contents

Operation Search

Settings Search

Index

Resetting the Settings

Setting
display

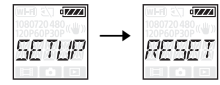

You can reset the settings to their defaults.
If you activate [RESET], images are not deleted.

- 1 Press the NEXT button to display [SETUP], then press the ENTER button.
- 2 Press the NEXT button to display [RESET] (Reset), then press the ENTER button.
- 3 Press the ENTER button to display [SURE?] while [OK] is displayed, then press the ENTER button again.

The camera automatically restarts when resetting is complete.

To cancel resetting, press the NEXT button to select [CANCL] while [SURE?] or [OK] is displayed, then press the ENTER button.

Table of
contents

Operation
Search

Settings
Search

Index

Format



Formatting is the process of deleting all images in the memory card, and restoring the memory card to its initial state.

To make the setting, select [SETUP] first.

- 1 Press the NEXT button to display [SETUP], then press the ENTER button.
- 2 Press the NEXT button to display [FORMT] (Format), then press the ENTER button.
- 3 Press the ENTER button to display [SURE?] while [OK] is displayed, then press the ENTER button again.

Formatting starts and [DONE] appears when formatting finishes.

To cancel formatting, press the NEXT button to select [CANCL] while [SURE?] or [OK] is displayed, then press the ENTER button.

Notes

- Save important images before formatting.
- Do not perform any of the following operations while formatting.
 - Press a button.
 - Eject the memory card.
 - Connect/disconnect a cable.
 - Insert/remove the battery pack.

Using accessories

Refer to the website of this camera for the latest information on accessories.

Waterproof Case (SPK-AS2)

By inserting the camera in the Waterproof Case, you can shoot movies in the rain or at a beach.

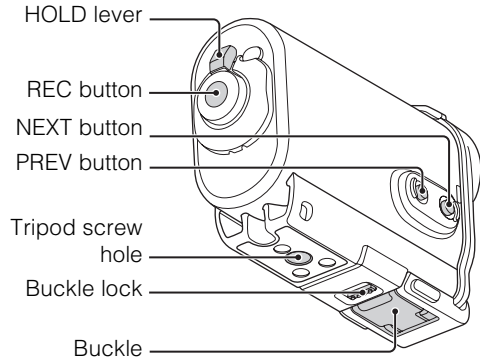
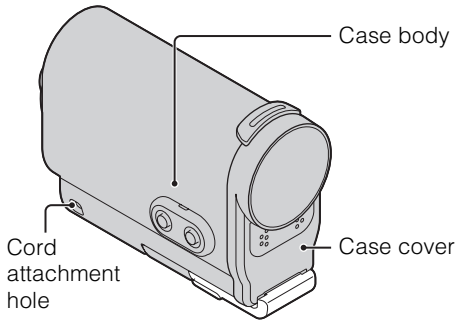

Attachment method

- 1 Slide the buckle lock in the direction of ① and hold it, then hold the circled parts and swing out the buckle in the direction of ②.

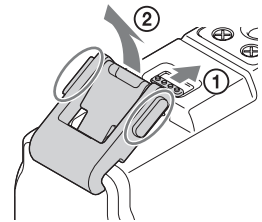

- 2 Open the case cover.

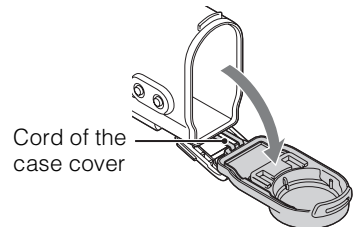

- 3 Insert the camera in the case body.
 - Release the ◀REC HOLD switch on the camera.

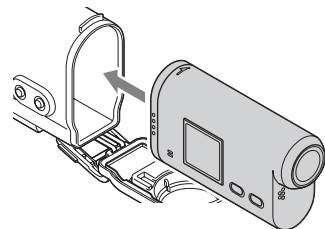

4 Insert the tab of the case body into the slot of the case cover.

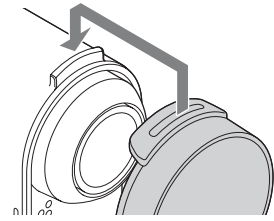

5 Hook the buckle over the tab on the lower part of the case cover ①, then close the buckle in the direction of ②, until it clicks into place.

- Close the buckle until the buckle lock returns to the original position.

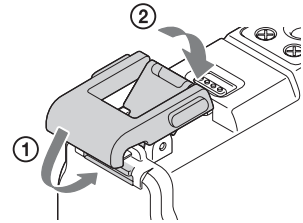

On waterproof performance

- The camera is operable up to a water depth of 5 m for 30 minutes. *
*When the camera is inserted.
- The waterproof performance is based on the testing standards of our company.
- Do not subject the Waterproof Case to pressurized water, such as from a tap.
- Do not use the Waterproof Case in hot springs.
- Use the Waterproof Case in the recommended operating water temperature range of 0°C to +40°C.
- Sometimes waterproof performance is lost if the Waterproof Case is subject to a strong shock such as from being dropped. We recommend the Waterproof Case be inspected at an authorized repair shop (chargeable).
- If you use the camera at a water depth of 5 m or more, or in marine sports, use the Waterproof Case (SPK-AS1) (sold separately).

Notes

- You cannot operate the REC button when the HOLD lever is set to the lock position. Release the lock before operation.
- When recording images underwater with the camera in the Waterproof Case, recorded images appear less clear than those of normal recording. This is not a malfunction.
- You can record audio while the camera is in the Waterproof Case, but the sound level is reduced.
- Thread a suitable cord through the attachment hole of the Waterproof Case, then attach the cord to an item you intend to use with the camera.

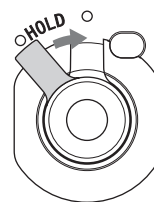

Notes on use

- Do not throw the Waterproof Case into the water.
- Avoid using the Waterproof Case under the following situations:
 - in a very hot or humid place.
 - in water hotter than 40°C (104°F).
 - at temperatures lower than 0°C (32°F).In these situations moisture condensation or water leakage may occur and damage the camera.
- Do not leave the Waterproof Case under direct sunlight or in a very hot and humid place for a long period of time. If you cannot avoid leaving the Waterproof Case under direct sunlight, be sure to cover the Waterproof Case with a towel or other protection.
- When the camera overheats, it may automatically turn off or recording may malfunction. To use the camera again, leave it in the cool place for a while to cool down.
- If sun oil is on the Waterproof Case, be sure to wash it off thoroughly using lukewarm water. If the Waterproof Case is left with sun oil on its body, the surface of the Waterproof Case may become discolored or damaged (such as cracks on the surface).

Water leakage

If water happens to leak in, stop exposing the Waterproof Case to water immediately.

- If the camera gets wet, take it to the nearest Sony dealer immediately. Repair costs must be borne by the customer.
- In the unlikely event that a malfunction of the Waterproof Case causes damage due to water leakage, Sony does not guarantee against damages to the equipment contained in it (camera, battery pack, etc.) and the recorded contents, nor expenses entailed in the photography.

O-ring

The Waterproof Case uses an O-ring to maintain its water resistance.

O-ring maintenance is very important. Failure to do O-ring maintenance according to the instructions may lead to water leaks and cause the Waterproof Case to sink.

Inspect the O-ring

- Carefully check that there is any dirt, sand, hair, dust, salt, threads, etc. on the O-ring. If found, be sure to wipe off with a soft cloth.
- Lightly run your fingertip around the O-ring to check for any invisible dirt.
- Be careful not to leave any cloth fibers on the O-ring after wiping it.
- Check the O-ring for cracks, skewing, distortion, fine splitting, scratches, embedded sand, etc. Replace the O-ring if you find any of these.
- Inspect the O-ring contact surface on the case body in the same way.

How to check for water leaks

Before installing the camera, always close the Waterproof Case and immerse it in water to make sure no water leaks in.

O-ring serviceable life

The serviceable life of the O-ring varies with frequency of use of the Waterproof Case and conditions. Generally, it is about one year.

Maintenance

- After recording in a location with a sea breeze, wash this unit thoroughly in fresh water with the buckle fastened to remove salt and sand, then wipe with a soft dry cloth. It is recommended that you submerge the Waterproof Case in fresh water for about 30 minutes. If it is left with salt on it, metal portions may be damaged or rust may form and cause water leakage.
- If sun oil is on the Waterproof Case, be sure to wash it off thoroughly using lukewarm water.
- Wipe the inside of the Waterproof Case with a soft dry cloth. Do not wash it with water.

Be sure to perform the above maintenance each time you use the Waterproof Case.

Do not use any type of solvent such as alcohol, benzine or thinner for cleaning, as this might damage the surface finish of the Waterproof Case.

When storing the Waterproof Case

- To prevent deterioration of the O-ring, store the Waterproof Case in a cool, well-ventilated location. Do not fasten the buckle.
- Prevent dust from collecting on the O-ring.
- Avoid storing the Waterproof Case in a cold, very hot or humid place, or together with naphthalene or camphor, as these conditions might damage the Waterproof Case.

Adhesive Mount (VCT-AM1)

The Adhesive Mount is used for fixing the Waterproof Case to an item you intend to use. The Adhesive Mount is a general term for the Attachment Buckle, Flat Adhesive Mount, and Curved Adhesive Mount. Insert the camera in the Waterproof Case before attaching.

Attachment Buckle

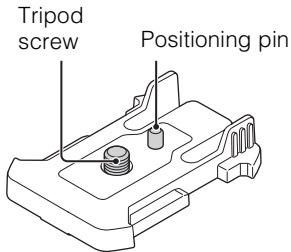

Flat Adhesive Mount

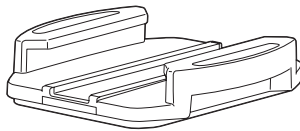

Curved Adhesive Mount

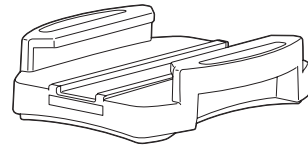

Attachment method

- 1 Align the tripod screw hole in the bottom of the Waterproof Case with the tripod screw hole of the Attachment Buckle, and fix firmly with the tripod screw.

- Confirm that the assembly is fixed securely.

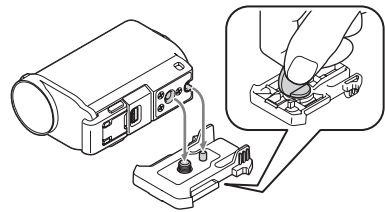

- 2 Attach the Attachment Buckle (with the Waterproof Case set in step 1) to the Flat Adhesive Mount or Curved Adhesive Mount by sliding it until it clicks into place.

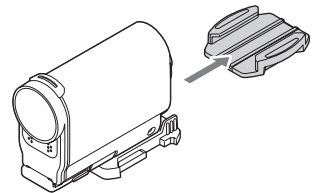

- 3 Remove dust, moisture and oily substances completely from the surface where the Adhesive Mount is to be attached.

- 4 Peel off the release paper on the back, and fix the Adhesive Mount in the desired location.

- Adhesive power reaches its maximum strength 24 hours after the Adhesive Mount is attached to the desired location.

To attach to or detach from the Attachment Buckle

Press and hold the circled part to unlock, then slide it in the opposite direction of step 2.

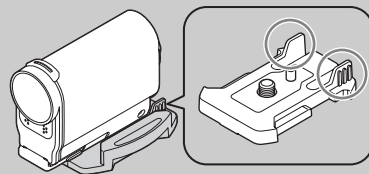

Notes

- The Flat Adhesive Mount and Curved Adhesive Mount cannot be used again once they are detached from the location surface.
- When detaching, peel off slowly. If peeled off forcibly, the surface on which the mount is fixed might be damaged.
- Before attaching, check the surface of the item to be used. If it is dirty, or dust, moisture or oily substances are attached, adhesive strength may be impaired and the item could detach with slight impact.
- Use the appropriate Adhesive Mount (flat or curved) for the surface where the camera will be located. If the mount is not suitable for the surface, it may detach by slight impact.
- Thread a suitable cord through the attachment hole of the Waterproof Case, then attach the cord to an item you intend to use with the camera.
- Before use, confirm that the screw hole on the Attachment Buckle is not loose, and the flat or curved Adhesive Mount is securely attached to the surface.

Shooting

Display



About the ◀ REC HOLD switch

The ◀ REC HOLD switch can prevent accidental operation. Slide the ◀ REC HOLD switch in the direction of ◀ to lock. To release the lock, slide it in the opposite direction of ◀.

- Before recording, release the lock.
 - If you lock the camera while recording, the recording state will be kept*.
 - If you lock the camera after you stop recording, the stopped state will be kept*.
- * Release the lock to change the setting.

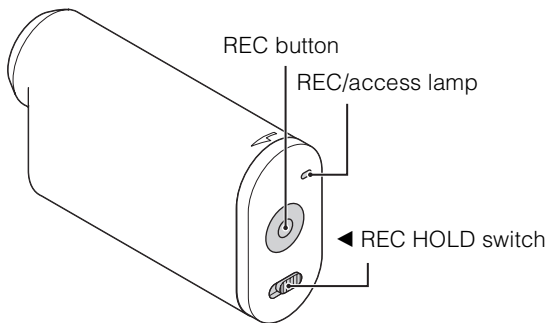

Movie mode

- 1 Turn on the power, then press NEXT button to display [MOVIE].
- 2 Press the REC button to start shooting.
- 3 Press the REC button again to stop shooting.

Photo mode

- 1 Turn on the power, then press NEXT button to display [PHOTO].
- 2 Press the REC button to start shooting.

Interval photo recording mode

After you start shooting, the camera records still images at regular intervals until you stop shooting.

- 1 Turn on the power, then press NEXT button to display [INTVL].
- 2 Press the REC button to start shooting.
- 3 Press the REC button again to stop shooting.

Notes

- If the shooting mode is changed, the mode set when the camera is turned off will be resumed when the camera is turned on the next time.

Notes on long-time recording

- When you continue to shoot for a long time, the temperature of the camera rises. If the temperature reaches above a certain level, shooting stops automatically.
Leave the camera for 10 minutes or longer to allow the temperature inside the camera to decrease to a safe level.
- Under high ambient temperatures, the temperature of the camera rises quickly.
- When the temperature of the camera rises, the image quality may deteriorate. It is recommended that you wait until the temperature of the camera drops before continuing to shoot.
- The surface of the camera may get hot. This is not a malfunction.

Table of
contents

Operation
Search

Settings
Search

Index

Viewing images on a TV

Display



Connect the camera to a TV which has an HDMI terminal using a micro HDMI cable (sold separately).

Refer also to the instruction manuals of the TV.

- 1 Turn off both the camera and the TV.
- 2 Open the connector cover and connect the camera to the TV with the micro HDMI cable (sold separately).

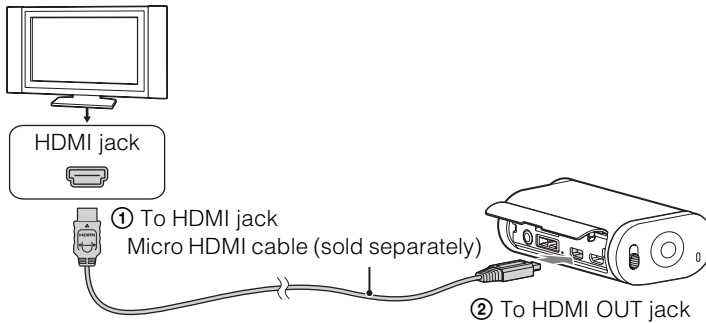

- 3 Set the input of the TV to [HDMI input].
- 4 Press the NEXT button on the camera to turn on.
- 5 Press the NEXT button to display [PLAY], then press the ENTER button.
- 6 Press the NEXT button to display [MP4] or [PHOTO], then press the ENTER button.

Select [MP4] to play back movies, or [PHOTO] to view photos.

Press the ENTER button again to stop playback.

Notes

- Connect the micro HDMI jack of the micro HDMI cable (sold separately) to the HDMI OUT jack of the camera.
- Do not connect the output terminal of the camera to that of other devices. This may result in malfunction.
- Some devices may not work properly. Image and sound may not be output.
- Use a micro HDMI cable (sold separately) with the HDMI logo.
- It is recommended that you use an authorized cable with HDMI logo or a Sony HDMI cable.

Table of contents

Operation Search

Settings Search

Index



To control a content being played back

- Viewing the previous/next image: Press the PREV/NEXT button.
- Fast-rewind/fast-forward (movies only): Press and hold the PREV/NEXT button.
- Pause (movies only): Press the PREV and NEXT buttons simultaneously. If you press and hold the PREV or NEXT button during pause, slow rewind or slow forward can be performed.
- Adjusting the volume (movies only): Press and hold the PREV and NEXT buttons simultaneously.
- Starting a slideshow (photos only): Press the PREV and NEXT buttons simultaneously.
- Ending playback: Press the ENTER button.

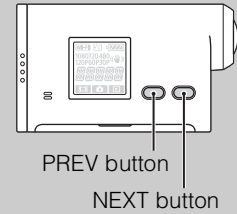

Preparation for setting Wi-Fi

Installing the “PlayMemories Mobile” software on your smartphone

Install the “PlayMemories Mobile” on your smartphone. Update “PlayMemories Mobile” to the latest version if you have already installed it on your smartphone.

For more information, refer to the following website.

<http://www.sony.net/pmm/>

Android 2.3 or later (Android 4.0 or later is required to use One-touch functions (NFC))

Search for “PlayMemories Mobile” on Google Play, then install it.



iOS 4.3 or later (One-touch functions (NFC) are not available)

Search for “PlayMemories Mobile” on App Store, then install it.



Notes

- An NFC-enabled smartphone or tablet is required for using One-touch functions (NFC).

Preparing the ID/password

- Have ready the sticker attached to the Operating Guide, on which the ID/password is printed.
- It is not necessary when using one-touch connect by a smartphone.

💡 If the password is lost

- ① Connect the camera to a computer with the micro USB cable (supplied).
- ② Turn on the power.
- ③ Display [Computer] → [PMHOME] → [INFO] → [WIFI_INF.TXT] on your computer, then check the user ID and password.

Setting Wi-Fi

Setting display



Android supporting NFC

1 Turn on the power of the camera, then press the NEXT button and select a shooting mode.

MOVIE: Movie mode



PHOTO: Photo mode

INTVL: Interval photo recording mode

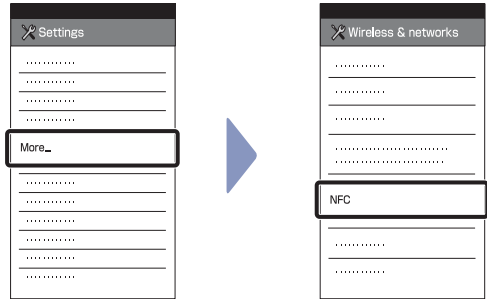
2 Select [Settings] on the smartphone, then select [More...] and check that [NFC] is enabled (First time only).



3 Touch the smartphone to the camera.

- Cancel sleep and the screen lock of the smartphone beforehand.
- Continue touching without moving until “PlayMemories Mobile” starts (1-2 seconds).
- Touch the  (N Mark) of the smartphone to the  (N Mark) of the camera. If there is no  (N Mark) on the smartphone, refer to the instruction manual of the smartphone for the touch area.
- If the camera and the smartphone cannot be connected by NFC, see “Android/iPhone not supporting NFC” and connect them.

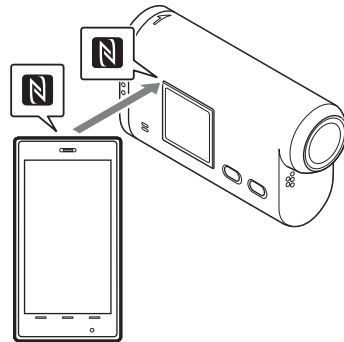

Notes

- When the airplane mode is set to [ON], the Wi-Fi function is not available.

About NFC

NFC is a technology for short-range wireless communication between various devices, such as a mobile phone and IC tag etc. Data communication is achieved simply by touching devices together at a specific point.

NFC (Near Field Communication) is an international standard of the short-range wireless communication technology.

Table of contents

Operation Search

Settings Search

Index

Android/iPhone not supporting NFC

Turn on the power of the camera, then press the NEXT button and select a shooting mode.

MOVIE: Movie mode

PHOTO: Photo mode

INTVL: Interval photo recording mode

Android

1 Start "PlayMemories Mobile."

2 Select the SSID, as printed on the sticker attached to the Operating Guide.

3 Input the password, as printed on the sticker attached to the Operating Guide (First time only).

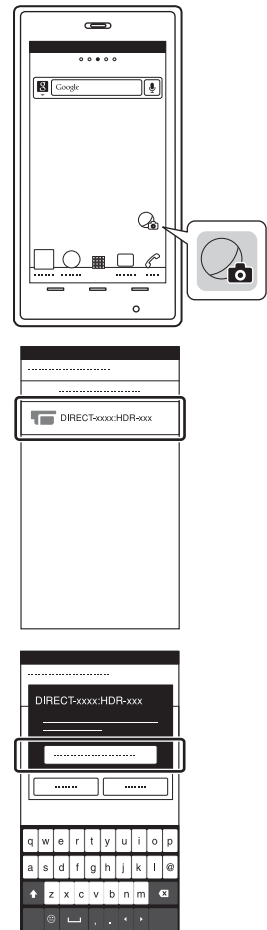

iPhone

- 1 Select [Settings] on the smartphone, then select [Wi-Fi] and the SSID of the camera.
- 2 Input the password, as printed on the sticker attached to the Operating Guide (First time only).
- 3 Confirm the connection to the SSID, as printed on the sticker attached to the Operating Guide.
- 4 Return to the home screen and start "PlayMemories Mobile."

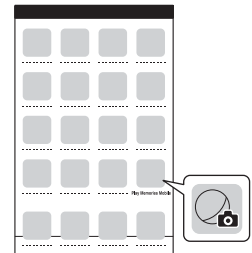
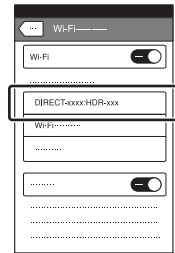
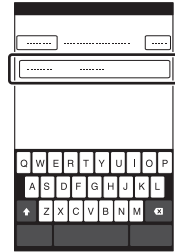
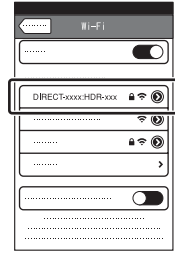

Smart Remote Control



By connecting the camera and a smartphone through Wi-Fi, you can operate the camera by the smartphone.

To make the setting, select [SETUP] first.

- 1 Press the NEXT button to display [SETUP], then press the ENTER button.
- 2 Press the NEXT button to display [Wi-Fi] (Wi-Fi), then press the ENTER button.
- 3 Press the NEXT button to select the setting, then press the ENTER button.

✓		Operates by the smartphone.
		Does not operate by the smartphone.
		Returns to the [Wi-Fi] menu.

- 4 Select [MOVIE], [PHOTO] or [INTVL].
- 5 Activate a suitable application on the smartphone, and connect to the camera through Wi-Fi.
For details on the smartphone setting, see “Setting Wi-Fi” on page 46.
- 6 Operate the camera by the smartphone.

Sample smartphone screen display

Features of the smart remote control function

- To check the field of view before and while recording
- To monitor images while recording

Various settings

- [VIDEO]
- [STEDY]
- [ANGLE]
- [SHARE]

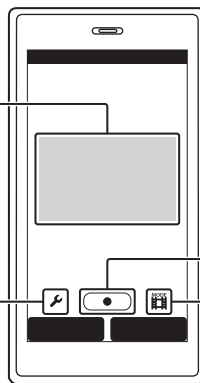

Start/stop recording

Shooting mode settings

- [MOVIE]
- [PHOTO]/[INTVL]

Notes

- The smart remote control function allows you to perform the following using a smartphone:
 - Checking the field angle
 - Recording start/stop
 - Changing the shooting mode (movie mode/photo mode/interval photo recording mode)
 - Copy mode (copy movies and photos shot by the camera)
 - Changing the Recording Mode setting (in movie mode only)
 - Changing the SteadyShot setting
 - Changing the field angle setting
- To use the smart remote control function, a compatible application is necessary on your smartphone. See page 45 for details on downloading applications.
- The camera battery charge may be consumed quickly if the camera is operated by a smartphone.
- If a Wi-Fi Direct connection request from a Wi-Fi Direct device appears on the shooting screen, press the ENTER button on the [ACPT?] screen. You can then operate the camera using the smart remote control function via the Wi-Fi Direct connection.

Copy

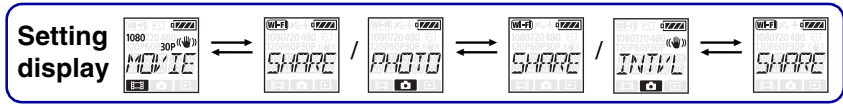

You can copy movies and photos shot by the camera by operating a smartphone.

- 1 Turn on the power of the camera, then press the NEXT button and select a shooting mode.

MOVIE: Movie mode

PHOTO: Photo mode

INTVL: Interval photo recording mode

- 2 Start “PlayMemories Mobile” on the smartphone and establish the Wi-Fi connection.

For details on the smartphone setting, see “Setting Wi-Fi” on page 46.

- 3 Change the mode of the camera to the copy mode on the “PlayMemories Mobile” screen of the smartphone.

- 4 Select the image(s) to be copied.

Notes

- Before activating the smart remote control function, update the “PlayMemories Mobile” software to the latest (ver.3.1 or later).
- You can copy images to your smartphone when the camera is set to a shooting mode (movie mode/photo mode/interval photo recording mode).
- You can change the mode only when shooting is in standby.

Useful functions when connecting the camera to your computer

The “PlayMemories Home” software allows you to import movies and still images to your computer to use them in a variety of ways.
Visit the following URL to install the software.
www.sony.net/pm/

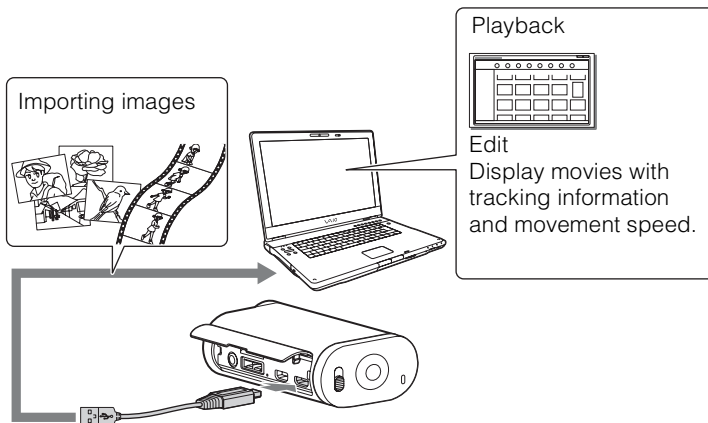

- Use the micro USB cable (supplied) when connecting the camera to your computer.
- Functions of “PlayMemories Home” that can be used differ for Windows and for Mac.
- For details on other applications, visit the following URL.
Windows: <http://www.sony.co.jp/imsoft/Win/>
Mac: <http://www.sony.co.jp/imsoft/Mac/>

Preparing a computer

Step 1 Checking the computer system

Windows:

OS* ¹	Windows Vista SP2/Windows 7 SP1/Windows 8
CPU* ²	Intel Core Duo 1.66 GHz or faster, or Intel Core 2 Duo 1.66 GHz or faster
Memory	1 GB or more
Hard disk	Disk space required for installation: Approximately 600 MB
Display	Minimum 1,024×768 dots
Others	USB port (this must be provided as standard, Hi-Speed USB (USB 2.0 compatible)) Either NTFS or exFAT file system is recommended as the hard disk file system.

Mac:

OS* ¹	Mac OS X (v10.6- v10.8), Equipped with Intel processor
Hard disk	Disk space required for installation: Approximately 100 MB
Display	Minimum 1,024×768 dots

*¹ Standard installation is required. Operation is not assured if the OS has been upgraded or in a multi-boot environment.

*² Faster processor is recommended.

Notes

- Operation with all computer environments is not assured.

Step 2 Installing the “PlayMemories Home” software

1 Turn on the computer.

- Log on as an Administrator.
- Close all applications running on the computer before installing the software.

2 Visit the following URL and download the software.

www.sony.net/pm/

The AutoPlay wizard is displayed.

3 Follow the instructions that appear on the computer screen to continue the installation.

When the installation completes, “PlayMemories Home” starts up.

- If the “PlayMemories Home” software is already installed on your computer, connect the camera to the computer, and register the camera with the “PlayMemories Home” software. Functions that can be used with this camera will then be available.
- If the “PMB (Picture Motion Browser)” software is installed on your computer, it will be overwritten by the “PlayMemories Home” software.
- For details on “PlayMemories Home” select  (“PlayMemories Home” Help Guide) on the software or visit the PlayMemories Home support page (<http://www.sony.co.jp/pmh-se/>).
- You can play movies recorded with the camera on the screen of the computer, when the camera is connected to a computer which has “PlayMemories Home” installed.

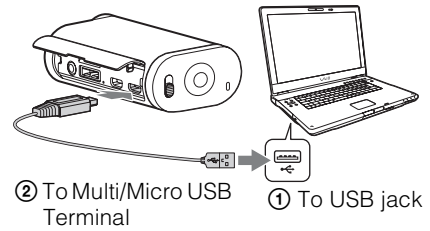

To delete the USB connection

Windows7/Windows8

- 1 Click  on the task tray.
- 2 Click the disconnect icon in Customize.
- 3 Click the device to remove.

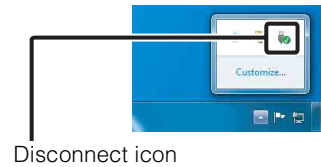

Windows Vista

Perform the procedure from step 1 to 3 below before:

- Disconnecting the micro USB cable (supplied).
- Turning off the camera.

- 1 Double-click the disconnect icon on the task tray.
- 2 Click  (USB Mass Storage Device) → [Stop].
- 3 Confirm the device on the confirmation window, then click [OK].

Notes

- Do not format the memory card of the camera using a computer. If you do this, the camera will not operate correctly.
- When you access the camera from the computer, use the “PlayMemories Home” software. Do not directly modify the files or folders on the camera from the computer. The image files may be damaged or may not be played back.
- Operation is not guaranteed, if you operate the data on the memory card of the camera from the computer.
- Use the “PlayMemories Home” software when you import long movies or edited images from the camera to a computer. If you use other software, the images may not be imported correctly.
- Drag and drop the drive icon to the “Trash” icon when you use a Mac computer, and the camera is disconnected from the computer.

Starting the “PlayMemories Home” software

1 Double-click the “PlayMemories Home” icon on the computer screen.

The “PlayMemories Home” software starts up.



2 For how to use “PlayMemories Home,” refer to the help of the “PlayMemories Home.”



Please register your product

- Sony asks you to register your product for enhanced support.
- For Mac users, use the Mac application “Product registration software.”

Table of contents

Operation Search

Settings Search

Index

Troubleshooting

If you experience trouble with the camera, try the following solutions.

① Check the items on pages 58 to 62.

② Turn the power off and then on again.

③ Consult your Sony dealer or local authorized Sony service facility.

Table of
contents

Operation
Search

Settings
Search

Index

Battery pack and power

Cannot turn on the camera.

- Attach a charged battery pack.
- Make sure that the battery pack is inserted correctly (page 15).

The power turns off suddenly.

- Depending on the camera and battery temperature, the power may turn off automatically to protect the camera. In this case, a message is displayed on the display panel before the power turns off.
- If you do not operate the camera for a certain period of time while the power is on, the camera turns off automatically to prevent wearing down the battery pack. Turn the camera on again.
- If you have selected [OFF] in the Auto Power Off function, the power does not turn off automatically.

Battery life is short.

- You are using the camera in an extremely hot or cold location, or the charging is insufficient. This is not a malfunction.
- If you have not used the camera for a prolonged period, the efficiency of the battery will be improved by repeatedly charging and discharging it.
- When usable battery life becomes half the usual time, even after charging the battery pack fully, the battery pack may need to be replaced. Consult your nearest Sony dealer.

Cannot charge the camera.

- Turn off the camera and make the USB connection.
- Disconnect the micro USB cable (supplied), and then reconnect it.
- Use the micro USB cable (supplied).
- Charge the battery pack in an ambient temperature of 10°C to 30°C (50°F to 86°F).
- Turn on the computer and connect the camera.
- Release the computer from sleep or hibernation status.
- Connect the camera directly to a computer using the micro USB cable (supplied).
- Connect the camera to a computer with the operating system that is supported by the camera.

The remaining charge indicator is incorrect.

- This phenomenon occurs when you use the camera in an extremely hot or cold location.
- A discrepancy arose between the remaining charge indicator and the actual remaining battery charge. Fully discharge the battery pack once, then charge it to correct the indication.
- Fully charge the battery pack again. If the problem persists, the battery pack is worn out. Replace the battery pack with a new one.

Memory card

Operations using the memory card cannot be performed.

- If you use a memory card formatted on a computer, format it again on the camera (page 34).

Shooting images

Cannot record images.

- Check the free capacity of the memory card.

Cannot insert dates on images.

- The camera does not have a feature for superimposing dates on images.

Viewing images

Cannot play back images.

- The folder/file name has been changed on your computer.
- Connect a micro HDMI cable (sold separately).

The image does not appear on the TV.

- Check whether the connection is correct (page 43).

GPS (HDR-AS30V only)

The camera is not receiving a GPS signal.

- Set the GPS log to [ON].
- Your camera may not be able to receive radio signals from GPS satellites because of obstructions.
- To triangulate the location information correctly, bring your camera to an open area, and turn on the camera again.

Excessive error in location information.

- The margin of error can be up to several-hundred meters depending on surrounding buildings, weak GPS signals, etc.

It takes time to triangulate although the GPS assist data is taken in.

- Date & Time Setting is not set, or set time is shifted greatly. Set the date and time correctly.
- The term of validity of GPS assist data has expired. Update GPS assist data.
- As the positions of GPS satellites vary constantly, it may take longer to determine the location or the receiver may not be able to determine the location at all, depending on the location and time you use the camera.
- “GPS” is a system for determining geographic location by triangulating radio signals from GPS satellites. Avoid using the camera in places where radio signals are blocked or reflected, such as a shadowy place surrounded by buildings or trees, etc. Use the camera in open sky environments.

The location information has not been recorded.

- Use “PlayMemories Home” to import the movies with GPS location information to your computer.

Computers

Your computer does not recognize the camera.

- When the battery level is low, charge the camera.
- Turn on the camera and connect to a computer.
- Use the micro USB cable (supplied).
- Disconnect the micro USB cable (supplied) from both the computer and the camera, and connect it again firmly.
- Disconnect all equipment other than the camera, the keyboard and the mouse from the USB connectors of your computer.
- Connect the camera directly to your computer without passing through a USB hub or other device.

Cannot import images.

- Connect the camera and your computer correctly making a USB connection (page 53).

“PlayMemories Home” cannot be installed.

- Check the computer environment or installation procedure required to install “PlayMemories Home.”

“PlayMemories Home” does not work correctly.

- Quit “PlayMemories Home” and restart your computer.

Cannot play back images on your computer.

- Consult the computer or software manufacturer.

Wi-Fi

It takes too much time to transfer an image.

- Microwave ovens or Bluetooth-enabled devices use the 2.4 GHz wavelength and could hinder the communication. If such devices are in the vicinity, move the camera away from those devices or shut those devices down.

Others

The lens gets fogged.

- Moisture condensation has occurred. Turn off the camera and wait about an hour for the moisture to evaporate.

The camera becomes warm when you use it for a long time.

- This is not a malfunction.

The date or time is incorrect.

- Set the date and time again (page 30).

Warning indicators and messages

If the following messages appear, follow the instructions.



- The battery level is low. Charge the battery pack immediately.

ERROR

- Turn the power off and then on again.

HEAT

- The camera temperature has risen. The power may turn off automatically, or you may be unable to record images. Leave the camera in a cool location until the temperature goes down.
- If you record images for an extended period, the camera temperature rises. In this case, stop recording images.

NoIMG

- The memory card does not contain playable images.

LowPw

- There is no remaining battery charge.

BATT

- Battery charge is insufficient for operation.
- The battery pack is delivering current exceeding the maximum discharge current (beyond which proper operation of the camera cannot be assured when an external microphone, etc., is connected).
- A different battery pack is detected when the camera is powered on.
- Battery pack deterioration is detected.

FULL

- Remaining capacity of the memory card is insufficient for recording.

MAX

- The maximum number of files that can be recorded has been reached.

MEDIA

- The memory card is not inserted properly.
- The memory card is damaged.
- The memory card format is incompatible with this camera.

NoCRD

- There is no memory card inserted.

NoDSP

- The camera is not connected to a TV when playback is started.

PLANE

- When the airplane mode is set to [ON], GPS and Wi-Fi cannot be used (page 27).

Table of contents

Operation Search

Settings Search

Index

Recordable time

Estimated duration of recording and playback for each battery pack

Recording time

Approximate time available when you use a fully charged battery pack.

(Units: minutes)

Battery pack	Continuous recording time		Typical recording time	
Image quality	HQ	VGA	HQ	VGA
NP-BX1 (supplied)	120 (140)	140 (175)	60 (80)	85 (110)

- Times measured when using the camera at 25°C (77°F). It is recommended that you use the camera from 10°C to 30°C (50°F to 86°F).
- The recording and playback time will be shorter when you use the camera in low temperatures.
- The recording and playback time may be shorter, depending on the recording conditions.
- () indicates the recording time when the smart remote control function is set to [OFF].

Playing time

Approximate time available when you use a fully charged battery pack.

Approximate time when images are played back on a TV connected with a micro HDMI cable (sold separately).

(Units: minutes)

Battery pack	Playing time	
Image quality	HQ	VGA
NP-BX1 (supplied)	205	210

Estimated recording time of movies

MP4AVC 2ch Average

(Units: minutes)

Recording Mode	8GB	16GB	32GB
PS	35	80	160
HQ	60	125	250
SSLOW	40	80	165
SLOW	80	165	330
STD	160	325	650
VGA	295	600	1205

- In the SLOW/SSLOW setting, the above figure indicates the recordable time when shooting and differs from actual playback time.
- When using a Sony memory card.

Notes

- The recordable time may vary depending on the recording conditions, subjects, and the Recording Mode (page 20).
- Continuous movie shooting time is approximately 13 hours.
In [SLOW] mode, it is approximately 6.5 hours.
In [SSLOW] mode, it is approximately 3 hours.

Estimated number of recordable photos

(unit: image)

	8GB	16GB	32GB
2M (Interval photo recording) (16:9)	10500	21000	40000
12M (Still images)	1300	2650	5300

- When using a Sony memory card.
- The number of recordable photos for the memory card shown is for the maximum image size for your camera. The actual number of recordable photos is displayed on the LCD screen during shooting.
- The number of recordable photos for a memory card may vary depending on the shooting conditions.

Battery pack

On charging the battery pack

- Charge the battery pack before using the camera for the first time.
- We recommend charging the battery pack in an ambient temperature of between 10°C to 30°C (50°F to 86°F) until the CHG (Charge) lamp turns off. The battery pack may not be effectively charged in temperatures outside this range.
- The CHG (Charge) lamp may blink in the following situation:
 - Battery pack is not attached correctly.
 - Battery pack is damaged.
- When the battery pack temperature is low, detach the battery pack and place it in warm surroundings.
- When the battery pack temperature is high, detach the battery pack and place it in cool surroundings.

Effective use of the battery pack

- Battery pack performance decreases in low temperature surroundings (less than 10°C (50°F)). So in cold places, the operational time of the battery pack is shorter. We recommend the following to ensure longer battery pack use: Put the battery pack in a pocket close to your body to warm it up, and insert it in the camera immediately before you start shooting.
- The battery pack will run out quickly if you use the playback, fast-forward, and fast-rewind frequently.
- Turn off the camera every time you do not shoot or playback on the camera. Battery pack is wearing out when the shooting is in standby.
- We recommend having spare battery packs handy for two times or three times the expected shooting time, and making trial shots before taking the actual shots.
- You may not be able to turn on the camera or the battery pack may not be effectively charged if the terminal section of the battery pack is dirty. In this case, wipe any dust with a soft cloth lightly to clean the battery pack.
- Do not expose the battery pack to water. The battery pack is not water-resistant.

About the remaining battery charge

- If the battery pack runs out so fast although the remaining charge indicator is high, fully charge the battery pack again. Remaining charge indicator will be displayed correctly. Note that it may not be displayed correctly in the following situations:
 - Using the camera for a long time in high temperature
 - Leaving the camera with fully charged battery pack
 - Using a heavily used battery pack

How to store the battery pack

- Fully discharge the battery pack before storing and store it in a cool, dry place. To maintain the battery pack's function, fully charge the battery pack and then fully discharge it on the camera at least once a year while storing.
- To prevent staining the terminal, short-circuiting, etc., be sure to use a plastic bag to keep away from metal materials when carrying or storing.

On battery pack life

- The battery pack life is limited. Battery capacity decreases over time and through repeated use. If decreased usage time between charges becomes significant, it is probably time to replace it with a new one.
- The battery pack life varies according to how a battery pack is used.

Using the camera abroad

On TV color systems

To view images shot by the camera on a TV, you need a TV (or monitor) with an HDMI jack and a micro HDMI cable (sold separately).

Before shooting, be sure to set [V.SYS] to the TV system of the country and region where you will view recordings. The following shows which countries and regions you can view [NTSC] or [PAL] images.

Countries and regions where you can view images when [V.SYS] is set to [NTSC]

Barbados, Bermuda, Bolivia, Canada, Chile, Columbia, Costa Rica, Cuba, Dominica, Ecuador, El Salvador, Guam, Guatemala, Guyana, Haiti, Honduras, Japan, Mexico, Micronesia, Myanmar, Nicaragua, Panama, Peru, Philippines, Puerto Rico, Republic of Korea, Saint Lucia, Samoa, Suriname, Taiwan, Trinidad and Tobago, United States of America, Venezuela etc.

Countries and regions where you can view images when [V.SYS] is set to [PAL]

Australia, Austria, Argentina, Belgium, Bulgaria, Brazil, China, Croatia, Czech Republic, Denmark, Finland, France, French Guiana, Germany, Greece, Hong Kong, Hungary, Indonesia, Iran, Iraq, Italy, Kuwait, Malaysia, Monaco, Netherlands, New Zealand, Norway, Paraguay, Poland, Portugal, Romania, Russia, Singapore, Slovakia, Spain, Sweden, Switzerland, Thailand, Turkey, Ukraine, United Kingdom, Uruguay, Vietnam etc.

World time difference

Time-zone differences	Area setting
GMT	Lisbon, London
+01:00	Berlin, Paris
+02:00	Helsinki, Cairo, Istanbul
+03:00	Nairobi
+03:30	Tehran
+04:00	Abu Dhabi, Baku, Moscow
+04:30	Kabul
+05:00	Karachi, Islamabad
+05:30	Kolkata, New Delhi
+06:00	Almaty, Dhaka
+06:30	Yangon
+07:00	Bangkok, Jakarta
+08:00	Hong Kong, Singapore, Beijing
+09:00	Seoul, Tokyo
+09:30	Adelaide, Darwin

Time-zone differences	Area setting
+10:00	Melbourne, Sydney
+11:00	Solomon Is
+12:00	Fiji, Wellington, Eniwetok, Kwajalein
-11:00	Samoa
-10:00	Hawaii
-9:00	Alaska
-8:00	Los Angeles, Tijuana
-7:00	Denver, Arizona
-6:00	Chicago, Mexico City
-5:00	New York, Bogota
-4:00	Santiago
-3:30	St.John's
-3:00	Brasilia, Montevideo
-2:00	Fernando de Noronha
-1:00	Azores, Cape Verde Is.

Precautions

Do not use/store the camera in the following places

- In an extremely hot, cold or humid place
In places such as in a car parked in the sun, the camera body may become deformed and this may cause a malfunction.
- Under direct sunlight or near a heater are not suitable places for storage.
The camera body may become discolored or deformed, and this may cause a malfunction.
- In a location subject to strong vibration
- Near strong magnetic fields
- In sandy or dusty places
Be careful not to let sand or dust get into the camera. This may cause the camera to malfunction, and in some cases may be irreparable.

On carrying

Do not sit down in a chair or other place with the camera in the back pocket of your trousers or skirt, as this may cause malfunction or damage the camera.

Care and storage of the lens

- Wipe the surface of the lens clean with a soft cloth in the following instances:
 - When there are fingerprints on the lens surface.
 - In hot or humid locations
 - When the lens is exposed to salty air such as at the seaside.
- Store in a well-ventilated location subject to little dirt or dust.
- To prevent mold, periodically clean the lens as described above.

On cleaning

Clean the camera surface with a soft cloth slightly moistened with water, then wipe the surface with a dry cloth. Do not use any of the following as they may damage the finish or the casing.

- Chemical products such as thinner, benzine, alcohol, disposable cloths, insect repellent, sunscreen or insecticide, etc.
- Do not touch the camera with any of the above on your hand.
- Do not leave the camera in contact with rubber or vinyl for a long time.

On operating temperatures

The camera is designed for use in temperatures between 0°C and 40°C (32°F and 104°F). Shooting in extremely cold or hot places that exceed this range is not recommended.

On moisture condensation

If the camera is brought directly from a cold to a warm location, moisture may condense inside or outside the camera. This moisture condensation may cause a malfunction of the camera.

If moisture condensation occurs

Turn off the camera and wait about 1 hour for the moisture to evaporate.

Note on moisture condensation

Moisture may condense when you bring the camera from a cold place into a warm place (or vice versa) or when you use the camera in a humid place as shown below.

- When you bring the camera from a ski slope into a warm place.
- When you bring the camera from an air conditioned car or room into a hot place outside.
- When you use the camera after a squall or a shower.
- When you use the camera in a hot and humid place.

How to avoid moisture condensation

When you bring the camera from a cold place into a warm place, put the camera in a plastic bag and seal it tightly. Remove the bag when the air temperature inside the plastic bag has reached the ambient temperature (after about 1 hour).

Notes on optional accessories

- Genuine Sony accessories may not be available in some countries/regions.

Note on disposal/transfer of the memory card

Even if you delete data in the memory card or format the memory card on the camera or a computer, you may not delete data from the memory card completely. When you give the memory card to somebody, it is recommended that you delete data completely using data deletion software on a computer. Also, when you dispose of the memory card, it is recommended that you destroy the actual body of the memory card.

On GPS (HDR-AS30V only)

- As the positions of GPS satellites vary constantly, it may take longer to determine the location or the receiver may not be able to determine the location at all, depending on the location and time you use the camera.
- GPS is a system that determines your position by receiving signals from satellites. Avoid using the GPS feature on your camera in places where radio signals are blocked or reflected, such as a shadowy place surrounded by buildings or trees, etc. Use the camera in open sky environments.
- You may not be able to record location information at locations or in situations where radio signals from the GPS satellites do not reach the camera as follows.
 - In tunnels, indoors or under the shade of buildings.
 - Between tall buildings or at narrow streets surrounded by buildings.
 - In underground locations, locations surrounded by dense trees, under an elevated bridge, or in locations where magnetic fields are generated, such as near high voltage cables.
 - Near devices that generate radio signals of the same frequency band as the camera: near 1.5 GHz band mobile telephones, etc.
- If you take images with the GPS log set to [ON], and upload those images to the Internet, the shooting location may be available to third parties. To prevent this, set GPS log to [OFF] before shooting.

On triangulation errors (HDR-AS30V only)

- If you move to another location right after turning the camcorder on, it may take a longer time for the camcorder to start triangulating, compared to when you stay in the same place.
- Error caused by the position of GPS satellites
The camcorder automatically triangulates your current location when the camcorder receives radio signals from 3 or more GPS satellites. The triangulating error allowed by the GPS satellites is about 10 m (33 feet). Depending on the environment of the location, the triangulating error can be greater. In this case, your actual location may not match the location on the map based on the GPS information. Meanwhile, the GPS satellites are controlled by the United States Department of Defense, and the degree of accuracy may be changed intentionally.
- Error during the triangulating process
The camcorder acquires location information periodically during triangulating. There is a slight time lag between when the location information is acquired and when the location information is recorded on an image, therefore, the actual recording location may not match the exact location on the map based on the GPS information.

On GPS use restriction (HDR-AS30V only)

- Use GPS in accordance with the situation and regulations of the countries/regions where you use the camcorder.

Specifications

Camera

[System]

Video signal

- NTSC color, EIA standards
- HDTV 1080/60i, 1080/60p specification
- PAL color, CCIR standards
- HDTV 1080/50i, 1080/50p specification

Image device:

- 7.77 mm (1/2.3 type)
- Exmor R CMOS sensor

Recording pixels (16:9):

- Interval photo recording mode:
 - Max. 2 000 000 pixels equivalent
 - Photo mode: Max 11 900 000 pixels equivalent

Gross: Approx. 16 800 000 pixels

Effective (movie, 16:9):

- Approx. 11 900 000 pixels

Effective (still, 16:9): Approx. 11 900 000 pixels

Lens: Carl Zeiss Tessar Lens

- F2.8
- f = 2.5 mm (1/8 in.)
- When converted to a 35 mm still camera
- For movies: 15.3 mm (5/8 in.) (16:9)*

Exposure control: Automatic exposure

File format:

- Still images: JPEG (DCF Ver. 2.0, Exif Ver. 2.3, MPF Baseline) compliant
- Movies: MPEG-4 AVC/H.264 (MP4)
- Audio: MPEG AAC

Recording media:

- “Memory Stick Micro” (Mark2) media
- microSD card (Class4 or faster)

Minimum illumination: 6 lx (lux)

* SteadyShot set to [OFF]

[Input and Output connectors]

HDMI OUT jack: HDMI micro connector

Multi/Micro USB Terminal*: micro-B/USB2.0

- Hi-Speed (mass-storage)

* Supports Micro USB compatible devices.

- USB connection is only for output.
(For customers in Europe)

[Power, general]

Power requirements:

- Rechargeable battery pack: 3.6 V (NP-BX1 (supplied))
- Multi/Micro USB Terminal: 5.0 V
- USB charging (Multi/Micro USB Terminal):
 - DC 5.0 V, 500 mA/800 mA

Charging time:

Via a computer

- NP-BX1 (supplied): Approx. 245 min

Via a AC-UD20 (sold separately)

- NP-BX1 (supplied): Approx. 175 min

Power consumption: 1.9 W (when the movie image size is [1920×1080/30p])

Operating temperature: 0°C to 40°C (32°F to 104°F)

Storage temperature: -20°C to +60°C (-4°F to +140°F)

Dimensions: Approx. 24.5 mm × 47.0 mm × 82.0 mm (31/32 inches × 1 7/8 inches × 3 1/4 in.) (W/H/D, excluding protrusions)

Mass: Approx. 65 g (2 oz) (camera only)

Mass (when shooting):

- Approx. 90 g (3.2 oz) (including NP-BX1 (supplied))

Microphone: Stereo

Speaker: Monaural

Rechargeable battery pack:

NP-BX1 (supplied)

- Maximum output voltage: DC 4.2 V

- Output voltage: DC 3.6 V

- Capacity: 4.5 Wh (1,240 mAh)

- Type: Li-ion

[Wireless LAN]

Corresponding standard: IEEE 802.11 b/g/n

Frequency: 2.4GHz

Supported security protocols: WPA-PSK/WPA2-PSK

NFC: NFC Forum Type 3 Tag compliant

[Accessories]

Waterproof Case (SPK-AS2)

- Dimensions: Approx. 35.5 mm × 62.0 mm × 96.0 mm (1 7/16 in. × 2 1/2 in. × 3 7/8 in.) (W/H/D, excluding protrusions)

- Mass: Approx. 55 g (1.9 oz)

- Pressure-resistance: Shooting underwater at a depth of 5 m (16 feet) for 30 continuous minutes is possible. *

*When the camera is inserted.

Adhesive Mount (VCT-AM1)

Attachment Buckle

- Dimensions: Approx. 43.5 mm × 14.0 mm × 58.5 mm (1 3/4 in. × 9/16 in. × 2 3/8 in.) (W/H/D, excluding protrusions)

- Mass: Approx. 15 g (0.5 oz)

Flat Adhesive Mount

Dimensions: Approx. 50.0 mm × 12.5 mm × 58.5 mm (2 in. × 1/2 in. × 2 3/8 in.) (W/H/D, excluding protrusions)

Mass: Approx. 14 g (0.5 oz)

Curved Adhesive Mount

Dimensions: Approx. 50.0 mm × 16.0 mm × 58.5 mm (2 in. × 21/32 in. × 2 3/8 in.) (W/H/D, excluding protrusions)

Mass: Approx. 16 g (0.6 oz)

Design and specifications are subject to change without notice.

Table of
contents

Operation
Search

Settings
Search

Index

Trademarks

- “Memory Stick,” “,” “Memory Stick Duo,” “MEMORY STICK DUO,” “Memory Stick PRO Duo,” “MEMORY STICK PRO DUO,” “Memory Stick PRO-HG Duo,” “MEMORY STICK PRO-HG DUO,” “Memory Stick Micro,” “MagicGate,” “MAGICGATE,” “MagicGate Memory Stick,” “MagicGate Memory Stick Duo,” “PlayMemories Home,” “PlayMemories Home” logo, “PlayMemories Mobile” and “PlayMemories Mobile” logo are trademarks or registered trademarks of Sony Corporation.
- The terms HDMI and HDMI High-Definition Multimedia Interface, and the HDMI Logo are trademarks or registered trademarks of HDMI Licensing LLC in the United States and other countries.
- Microsoft, Windows and Windows Vista are either registered trademarks or trademarks of Microsoft Corporation in the United States and/or other countries.
- Mac, Mac OS and App Store are registered trademarks of App Inc.
- Intel, Intel Core, and Pentium are trademarks or registered trademarks of Intel Corporation or its subsidiaries in the United States and other countries.
- Adobe, the Adobe logo, and Adobe Acrobat are either registered trademarks or trademarks of Adobe Systems Incorporated in the United States and/or other countries.
- microSDXC logo is a trademark of SD-3C, LLC.
- The N Mark is a trademark or registered trademark of NFC Forum, Inc. in the United States and in other countries.
- iOS is a registered trademark or trademark of Cisco Systems, Inc. and/or its affiliates in the United States and certain other countries.
- Android, Google Play are trademarks of Google Inc.
- iPhone is a trademark or a registered trademark of Apple Inc.
- Wi-Fi, the Wi-Fi logo, Wi-Fi PROTECTED SET-UP are registered trademarks of the Wi-Fi Alliance.

In addition, system and product names used in this manual are, in general, trademarks or registered trademarks of their respective developers or manufacturers. However, the TM or © marks are not used in all cases in this manual.

On GNU GPL/LGPL applied software

The software that is eligible for the following GNU General Public License (hereinafter referred to as “GPL”) or GNU Lesser General Public License (hereinafter referred to as “LGPL”) are included in the camera.

This informs you that you have a right to have access to, modify, and redistribute source code for these software programs under the conditions of the supplied GPL/LGPL.

Source code is provided on the web. Use the following URL to download it. When downloading the source code, select HDR-AS30V as the model for your camera.

<http://www.sony.net/Products/Linux/>

We would prefer you do not contact us about the contents of source code.

Copies of the licenses (in English) are stored in the internal memory of your camera.

Establish a Mass Storage connection between your camera and a computer, and read the files in the “LICENSE” folder in “PMHOME.”

Index

A

A.OFF.....	28
Airplane mode.....	27
ANGLE.....	22
Auto power off.....	28

B

Battery pack.....	65
BEEP.....	29
Beep.....	29

C

Charging.....	16
CHG (Charge) lamp.....	16
Copy.....	51

D

DATE.....	30
Date & Time setting.....	30

E

ENTER (Menu execute) button.....	11
----------------------------------	----

F

Field angle.....	22
Format.....	34
FORMT.....	34

G

GPS.....	25
GPS Log.....	25

H

HDMI OUT jack.....	43
--------------------	----

I

Identifying parts.....	13
Interval photo recording.....	24
Interval photo recording mode.....	41
INTVL.....	41

L

LAPSE.....	24
------------	----

M

MOVIE.....	41
Multi/Micro USB Terminal.....	54

N

NEXT button.....	11
NFC.....	46
Number of recordable photos.....	64

P

PHOTO.....	41
PLANE.....	27
PLAY.....	43
PREV button.....	11

R

REC button.....	41
REC HOLD switch.....	41
REC/access lamp.....	41
Recordable time of movies.....	63
Recording mode.....	20
RESET.....	33
Resetting the settings.....	33

S

SCENE.....	23
Scene.....	23
Settings.....	11
Shooting	
Movies.....	41
Still image.....	41
Smart remote control.....	49
SteadyShot.....	21
STEDY.....	21
Switching NTSC/PAL.....	32

T

Troubleshooting.....	57
----------------------	----

U

USB.....	16
USB power supply.....	31
USBPw.....	31

V

V.SYS.....	32
VIDEO.....	20
View	
Movies.....	43
Still image.....	43

W

Warning messages.....	61
Wi-Fi.....	46